

measure analyse optimise



NivuMaster
Contactless
Level Measurement



NivuMaster - optimum Level Measurement

NivuMaster-Series transmitters supply connected P & R-Series sensors, process the measurement values and indicate the readings. The NivuMaster units are ideally suited for basic regulation and control tasks in level measurement applications.

Flow metering is possible without any problems in open channels using Venturi or Q/h relations as well as on any kind of weirs or overflow sills .

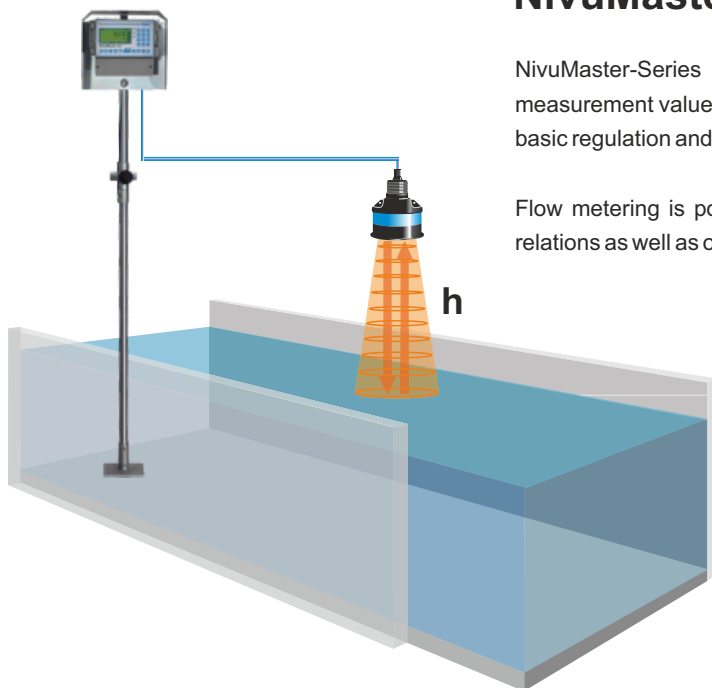

Non-Contact Ultrasonic Level Measurement

The sensor continuously transmits ultrasonic impulses which are reflected from the surface of the liquid. The reflected waves are detected by the sensor again. Level, distance or volume are calculated depending on the sound transit time.

FMCW Radar Function Principle

The R-Series sensors emit a continuous transmit signal with a changing operating frequency. By comparing this transmit signal with the reflected receive signal it is possible to determine the transit time frequency difference Δf . Using this transit time frequency difference and a specific mathematical formula allows computing a distance which then is converted to a concrete filling level.



P-Series Sensors:

P-Series sensors are suitable for continuous level measurement in the water and wastewater area. For connection to NivuMaster-Series evaluation units.

The ultrasonic sensors with integrated temperature compensation are for connection to NivuMaster-Series evaluation units and provide numerous metering options for liquids. The sensors are available in 1"- threaded connection or as DIN flange version and are assembled for easy mounting.

- Very low maintenance due to contactless measurement
- Extremely versatile due to measurement ranges from 0.07 m to 40 m
- Protection rating IP 68
- ATEX approval for Ex zones 0 and 1
- Alarm output in case of flood possible

R-Series Sensors:







The new R-Sensor is a radar sensor for continuous and contactless level measurement in liquids, pastes, sludges and bulk solids.

Measurements are not affected by changing media, temperature fluctuations, gas overlays or vapours. The radar sensor utilises the latest 63 GHz FMCW technology which, compared to pulsed radar methods, has several advantages. R-Series sensors provide accurate measurement values in closed tanks or outdoor applications (e. g. dams, rivers etc.). A very low dead zone and the narrow beam angle allow for reliable measurements even in confined spaces.

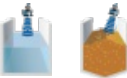
- Latest FMCW radar technology
- Insensitive to gas, pressure, mists or temperature fluctuations
- Measures through plastic containers
- Robust and flood-proof IP68 housing
- ATEX approval for Ex zones 0 and 1
- Improved spatial allocation
- Larger dynamic range
- More reliable surface detection



The NivuMaster Transmitters: always the right solution

		NivuMaster L-2	NivuMaster 5 Relays
Level measurement/distance measurement		+ + / +	+ +
Volumetric measurement/ empty space measurement		+ + / +	+ +
Pump control/slide valve control		-	+ +
Volume measurement		-	+ +
Comparative measurement		-	+ +
Measurement on stormwater overflow tanks		-	+ +
Operation			
Display		optional	+
Keys		optional	+
Inputs			
Sensors / optional 4-20 mA / digital		1 / - / -	2 / optional 4-20 mA / -
Outputs			
Relays / mA-output		2 / 1	5 / 1
RS232 interface		1	1
Construction			
Wall mount IP65 / DIN rail mounting		IP66/ -	+ / +
19" version (rack mount)		-	+
Panel mount		-	+
Ex approval according to ATEX		Zone 0, 1 and 2	Zone 0, 1 and 2
		Compact standard model with 2 relays for measurement of level and volume.	For measurement of distance, level and volumes as well as for pump control and extended control tasks.

Dimensions

Wall mount enclosure 5 Relays

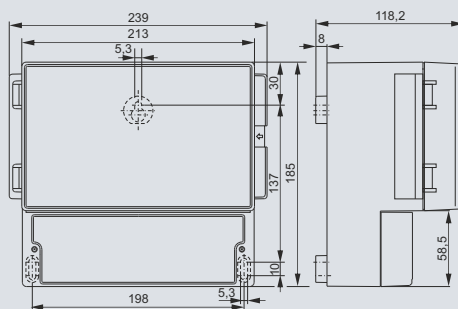

19" - version (Rack mount)

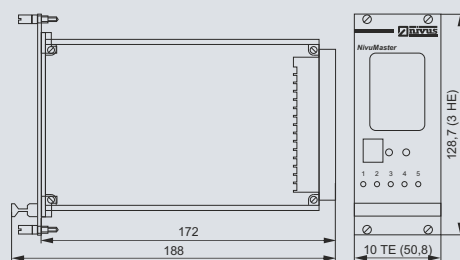

NivuMaster LD-5:2	NivuMaster LF-5:2	NivuMaster Plus
+	+	+
+	+	+
+	+	+
+	+	+
+	+	+
+	+	+
+	+	+
2 / - / -	1 / - / -	2 / opt. 4-20 mA / 7 dig.
5 / 2	5 / 2	6 / 1
1	1	1
+ / +	+ / +	- / -
-	-	-
-	-	+
Zone 0, 1 and 2	Zone 0, 1 and 2	Zone 0, 1 and 2
Model for 2 sensors, particularly designed for comparative screen measurements. For measurement and output of difference and level.	Particularly designed for stormwater treatment plants. For independent measurement and output of tank level and overflow volume with only one sensor.	Particularly designed for pump management. For comfortable control of up to 5 pumps and output of errors.

- Measurement of level, distance, volume, difference and flow
- Alarm output in case of flood possible
- Energy and cost-efficient pump control due to intelligent pump management
- High measurement reliability through integrated agitator avoidance
- Connection of maintenance-free and Ex-protected ultrasonic and radar sensors
- Up to 6 relays and galvanically isolated mA outputs
- Easy echo analysis and setting of parameters using free PC software
- Integrated emergency power switchover
- Easy operation in dialog mode using back-lit graphic display

No matter if high accuracy of flow measurements, interference-proof digital echo analysis or difficult measurements – the NivuMaster can handle all tasks. The few parameters required for measuring can be easily entered using the plain text dialog, the backlit display and the keypad. Moreover the serial interface allows to evaluate the readings using the “PC Software Suite”.

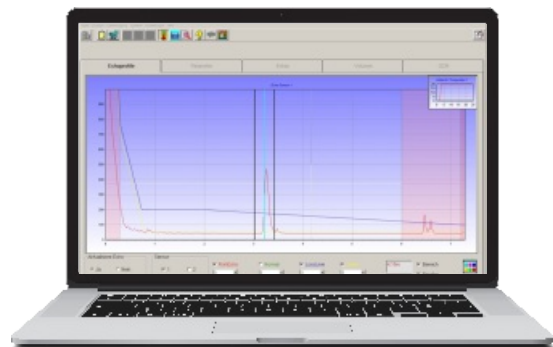

Convenient evaluation of measurement data on PC

Wall mount enclosure NivuMaster L-2

Panel mount enclosure

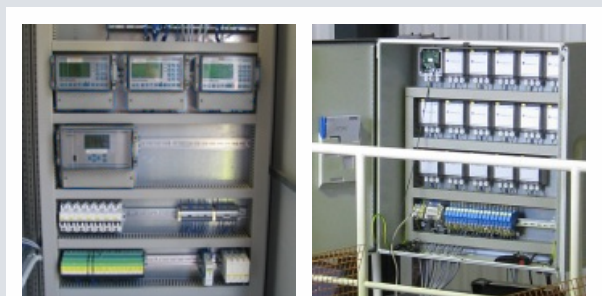
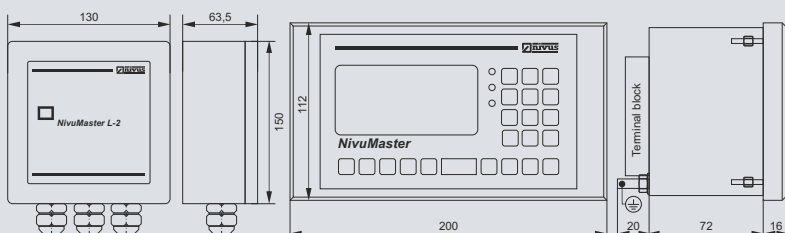

NivuMaster: Versatility is its strength

Level measurements

Contactless, maintenance-free level control and measurement in liquids and solids play an important role in the industrial and municipal areas. The high precision and operational safety is of importance in fulfilling these standards. The NivuMaster is an efficient measurement device that meets all these modern requirements for accurate measurements.

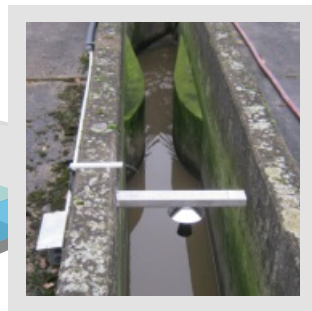
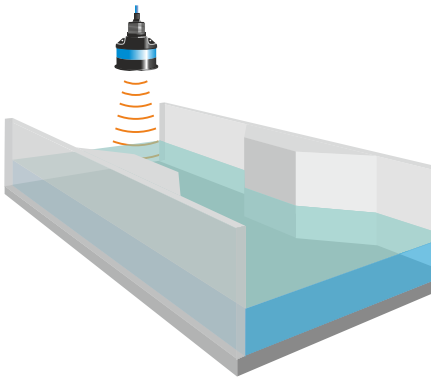
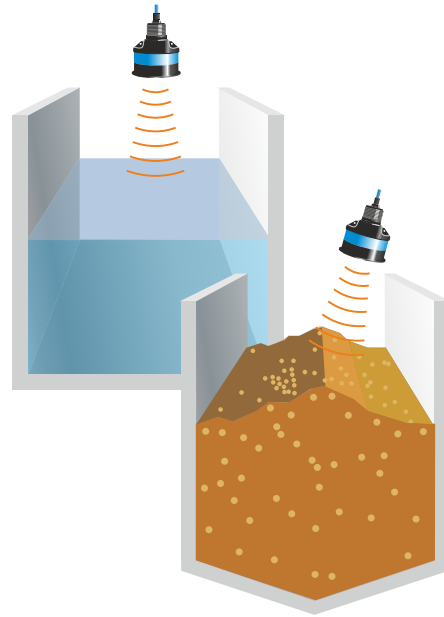

Volume measurement



The NivuMaster measures flow in channels and overflow structures with highest precision. The most common standard channels and weir forms are integrated into the device and can be easily programmed. Furthermore, a linearisation curve can be set up easily. The graphic display shows the flow readings in the desired units.





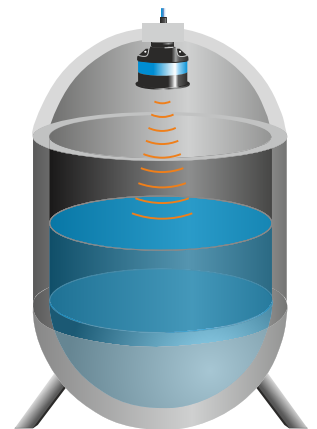
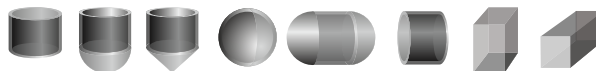



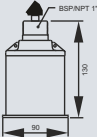
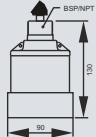

Volumetric measurements

No matter what container size or shape, the NivuMaster can convert the level measurement into volume with the ability to store standard pre-programmed vessel shapes. Also, a non-standard shape can be freely programmed with custom linearisation capability in the NivuMaster.

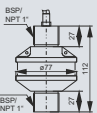
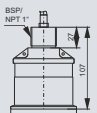
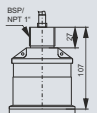
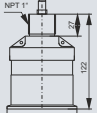
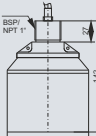
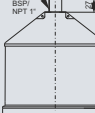

Type	R-8	R-8z	R-16	R-16z
				
Range	0.077 to 8 m	0.077 to 8 m	0.077 to 16 m	0.077 to 16 m
Resolution	+/- 1 mm			
Meas. Uncertainty	+/- 2 mm			
Frequency	63 GHz / V-Band			
Ambient Pressure	-0.5 to +4.0 bar			
Temperature	- 40 °C ... + 80 °C			
Beam Angle ↘	8°			
Ex Approval	ATEX - Zone 1 ATEX - Zone 0 (optional)			
Enclosure	Material: Valox 357U / Protection: IP68 / NEMA 6P			
Cable Length	5 m, 10 m, 20 m, 30 m, 50 m and 100 m; special lengths upon request			
Dimensions				

Type	P-M3	P-03	P-S6	P-06	P-10	P-15	P-25	P-40
								
Range	0.07 to 2.4 m	0.125 to 3 m	0.2 to 6 m	0.3 to 6 m	0.3 to 10 m	0.5 to 15 m	0.6 to 25 m	1.2 to 40 m
Resolution	+/- 0.5 mm	+/- 2 mm						
Meas. Uncertainty	1 mm	0.25 %						
Frequency	125 kHz	75 kHz	50 kHz	41 kHz	30 kHz	20 kHz		
Ambient Pressure	-0.5 to +5.0 bar							
Temperature	-30°C to 95°C (Ex -30°C to 75°C)		-40°C to 95°C (-40°C to 75°C if operated in Ex zone)					
Beam Angle ↘	12°	12°	10°	9°	10°	7°		
Ex Approval	ATEX - Zone 1 ATEX - Zone 0 (optional)							
Enclosure	Material: Valox 357 (PBT) / Protection: IP68							
Cable Length	5 m, 10 m, 20 m, 30 m, 50 m and 100 m; special lengths upon request							
Option*	Weatherproof cover & flood protection head incl.	Flood Protection Head (SUB)					not available	
	not available	PVDF enclosure for aggressive media up to max. 70 °C				not available		
Dimensions								

*There are many extensions optionally available which are not particularly mentioned in the list, e.g. soft foam coatings or various flange versions

NIVUS GmbH

Im Täle 2
75031 Eppingen, Germany
Tel.: +49 (0)7262 9191-0
Fax: +49 (0)7262 9191-999
info@nivus.com
www.nivus.com

NIVUS AG

Burgstrasse 28
8750 Glarus, Switzerland
Tel.: +41 (0)55 6452066
Fax: +41 (0)55 6452014
swiss@nivus.com
www.nivus.com

NIVUS Austria

Mühlbergstraße 33B
3382 Loosdorf, Austria
Tel.: +43 (0)2754 567 63 21
Fax: +43 (0)2754 567 63 20
austria@nivus.com
www.nivus.com

NIVUS Sp. z o.o.

ul. Hutnicza 3 / B-18
81-212 Gdynia, Poland
Tel.: +48 (0)58 7602015
Fax: +48 (0)58 7602014
biuro@nivus.pl
www.nivus.pl

NIVUS France

67870 Bischöfheim, France
Tel.: +33 (0)388999284
info@nivus.fr
www.nivus.fr

NIVUS Ltd.

Head office UK:
Wedgewood Rugby Road
Weston under Wetherley
Royal Leamington Spa
CV33 9BW, Warwickshire, UK
Tel.: +44(0)1926632470
info-uk@nivus.com
www.nivus.com

NIVUS Middle East (FZE)

Building Q 1-1, ap. 055
P.O. Box: 9217
Sharjah Airport International
Free Zone
Tel.: +971 6 55 78 224
Fax: +971 6 55 78 225
middle-east@nivus.com
www.nivus.com

NIVUS Korea Co. Ltd.

#2502, M Dong, Technopark IT Center
32 Song-do-gwa-hak-ro, Yeon-su-gu,
INCHEON, Korea 21984
Tel.: +82 32 209 8588
Fax: +82 32 209 8590
korea@nivus.com
www.nivus.com

NIVUS Vietnam

21 Pho Duc Chinh, Ba Dinh,
Hanoi, Vietnam
Tel.: +84 12 0446 7724
vietnam@nivus.com
www.nivus.com

Accessories for Contactless Level Sensors

The mounting accessories allow quick and easy installation of ultrasonic level sensors.

- Easy installation of level sensors
- Robust construction made of stainless steel
- Includes all fastening materials

The robust, high-quality accessories are made of stainless steel (1.4571) and are suitable for indoor and outdoor installation. All accessories are shipped completely including the required fastening materials which enables easy installation of sensors on ceiling or wall.

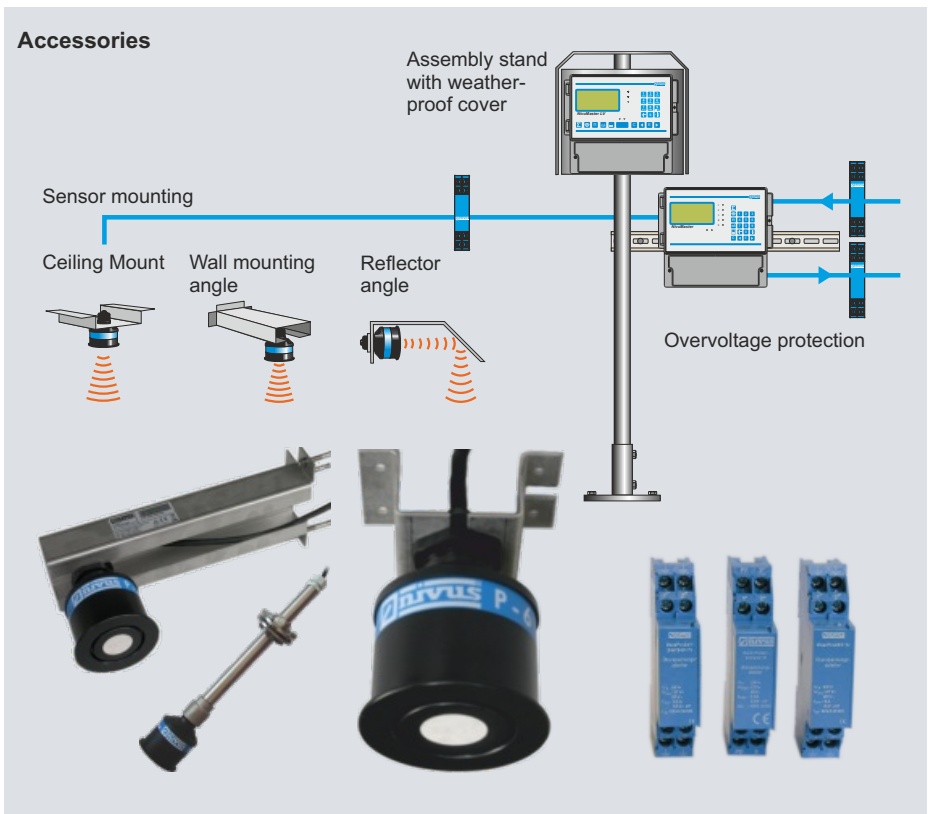

You can find more accessories and more information in the according manuals or on www.nivus.com