

Instruction Manual

Flow Measurement Transmitter NivuFlow Energy Saver



Firmware Revision: 2.20

Document revision: 00 / 12.01.2018

Original manual: German, rev. 00 as of 21.12.2017

NIVUS AG, Switzerland

Burgstrasse 28
8750 Glarus, Switzerland
Phone: +41 (0)55 6452066
Fax: +41 (0)55 6452014
swiss@nivus.com
www.nivus.de

NIVUS, Austria

Mühlbergstraße 33B
3382 Loosdorf, Austria
Phone: +43 (0) 2754 567 63 21
Fax: +43 (0) 2754 567 63 20
austria@nivus.com
www.nivus.de

NIVUS Sp. z o.o., Poland

ul. Hutnicza 3 / B-18
81-212 Gdynia, Poland
Phone: +48 (0) 58 7602015
Fax: +48 (0) 58 7602014
biuro@nivus.pl
www.nivus.pl

NIVUS, France

14, rue de la Paix
67770 Sessenheim, France
Phone: +33 (0)3 88071696
Fax: +33 (0)3 88071697
info@nivus.fr
www.nivus.fr

NIVUS Ltd., United Kingdom

Wedgewood Rugby Road
Weston under Wetherley
Royal Leamington Spa
CV33 9BW, Warwickshire
Phone: +44 (0)8445 3328 83
nivusUK@nivus.com
www.nivus.com

NIVUS Middle East (FZE)

Building Q 1-1 ap. 055
P.O. Box: 9217
Sharjah Airport International
Free Zone
Phone: +971 6 55 78 224
Fax: +971 6 55 78 225
middle-east@nivus.com
www.nivus.com

NIVUS Korea Co. Ltd.

#2502, M Dong, Technopark IT Center,
32 Song-do-gwa-hak-ro,
Yeon-su-gu,
INCHEON, Korea 21984
Phone: +82 32 209 8588
Fax: +82 32 209 8590
korea@nivus.com
www.nivus.com

NIVUS Vietnam

21 Pho Duc Chinh, Ba Dinh,
Hanoi, Vietnam
Phone: +84 12 0446 7724
vietnam@nivus.com
www.nivus.com

NIVUS Chile

Viña Cordillera Oriente 4565
Puente Alto, Santiago
Phone: +562 2266 8119
chile@nivus.com
www.nivus.com

Copyrights and property rights

This document and its contents are proprietary to NIVUS GmbH and are not to be reproduced or copied without the express written permission of NIVUS GmbH.

Violations oblige to compensation.



Important Note

This instruction manual may exclusively - even in parts - be copied or translated in any other way with the express written consent of NIVUS GmbH.

Translation

If the device is sold to a country in the European Economic Area (EEA) this instruction manual must be translated into the language of the country in which the device is to be used.

Should the translated text be unclear, the original instruction manual (German) must be consulted or the manufacturer contacted for clarification.

Copyright

No part of this publication may be reproduced, transmitted, sold or disclosed without prior permission. Damages will be claimed for violations.

All rights reserved.

Names

The use of general descriptive names, trade names, trade-marks and the like in this manual does not entitle the reader to assume they may be used freely by everyone. They are often protected registered trademarks even if not marked as such.

Table of Contents

COPYRIGHTS AND PROPERTY RIGHTS **3**

GENERAL **10**

| | | |
|----------|--|-----------|
| 1 | About this manual | 10 |
| 1.1 | Applicable documentation..... | 10 |
| 1.2 | Signs and definitions used..... | 11 |
| 1.3 | Abbreviations used | 11 |
| 2 | Connections and user elements | 11 |
| 2.1 | Power supply | 11 |
| 2.2 | NivuFlow control elements..... | 12 |
| 2.3 | Tasks of control elements | 12 |
| 2.4 | Interfaces | 13 |

SAFETY INSTRUCTIONS **14**

| | | |
|----------|--|-----------|
| 3 | In general: Used symbols and signal words | 14 |
| 3.1 | Valuation of the accident level | 14 |
| 3.2 | Warning notices on the product (option) | 15 |
| 4 | Safeguards and Precautions | 15 |
| 5 | Liability disclaimer | 16 |
| 6 | Use in accordance with the requirements | 16 |
| 7 | User's Responsibilities | 17 |
| 8 | Personnel requirements | 18 |

PRODUCT SPECIFICATION **19**

| | | |
|----------|--|-----------|
| 9 | Product construction and overview | 19 |
| 9.1 | Dimensions of enclosure | 20 |

| | | |
|------------------------------------|--|-----------|
| 9.2 | Connectable sensors | 21 |
| 9.3 | Device identification | 21 |
| 10 | Specifications | 22 |
| 11 | Configuration | 24 |
| 11.1 | Device Types | 24 |
| 11.2 | Delivery | 24 |
| 11.3 | Reception inspection | 24 |
| 11.4 | Storing | 25 |
| 11.5 | Transport..... | 25 |
| 11.6 | Return | 25 |
| 11.7 | Installation of spare parts and parts subject to wear and tear | 25 |
| FUNCTIONAL PRINCIPLE | | 26 |
| 12 | Operating Range..... | 26 |
| 13 | Functional Principles | 27 |
| 13.1 | Flow Velocity Measurement..... | 27 |
| 13.1.1 | Ultrasonic Cross Correlation..... | 27 |
| 13.2 | Level measurement in Pump Shaft..... | 29 |
| 13.2.1 | External level sensor | 29 |
| INSTALLATION AND CONNECTION | | 30 |
| 14 | General Installation Instructions..... | 30 |
| 14.1 | Hints on how to avoid electrostatic discharge (ESD)..... | 30 |
| 14.2 | Installation and Mounting versions | 30 |
| 14.3 | Choosing the installation place | 31 |
| 14.4 | Transmitter fastening on DIN rail in control cabinets | 32 |
| 14.5 | Field enclosure fastening and preparing electric installation | 32 |
| 15 | Electric Installation..... | 34 |
| 15.1 | Connection to the Terminal Blocks | 34 |
| 15.2 | Plans of terminal connections..... | 36 |

| | | |
|---------------------------|--|-----------|
| 15.3 | Switching on voltage supply | 37 |
| 15.3.1 | Power supply DC..... | 37 |
| 15.3.2 | Power supply AC | 38 |
| 15.4 | Relays..... | 39 |
| 16 | Installation and connection of sensors..... | 40 |
| 16.1 | Sensor Installation Principles..... | 40 |
| 16.2 | Cable and cable lengths for sensor connection..... | 40 |
| 16.3 | Connection of Intelligent Ex Separator Module iXT and Multiplexer MPX..... | 41 |
| 16.4 | Sensor Connection at NivuFlow | 42 |
| 16.4.1 | Connecting flow velocity sensors | 42 |
| 16.4.2 | Connection of level sensors | 43 |
| 16.4.3 | Special Points for Sensor Connection in Ex-Area Zone 1 .. | 44 |
| 17 | Overvoltage Protection | 45 |
| OPERATION START-UP | | 48 |
| 18 | Notes to users..... | 48 |
| 19 | Operation Basics | 49 |
| 19.1 | Display Overview | 49 |
| 19.2 | Using the Control elements | 49 |
| 19.3 | Use/Entry using the letter block..... | 50 |
| 19.4 | Use/Entry using the numeric keypad..... | 51 |
| 19.5 | Revision of parameters..... | 52 |
| 19.6 | Menus | 52 |
| MAIN DISPLAY | | 53 |
| 20 | General overview | 53 |
| 20.1 | Display Flow | 55 |
| 20.2 | Display Efficiency..... | 56 |
| 20.3 | Display Velocity | 56 |
| 20.4 | Display Level Shaft..... | 57 |
| 20.5 | Display Sum..... | 58 |

| | | |
|------|----------------------|----|
| 20.6 | Display Pump (1...4) | 59 |
|------|----------------------|----|

SETTING PARAMETERS

60

| | | |
|-----------|---|-----------|
| 21 | General Programming | 60 |
| 21.1 | Save Parameters | 60 |
| 21.2 | Change Password | 60 |
| 22 | Parameter Functions | 61 |
| 22.1 | Main Menu | 61 |
| 22.2 | Functions Top Menu Level | 61 |
| 22.2.1 | Application Menu | 61 |
| 22.2.2 | Data Menu | 62 |
| 22.2.3 | System Menu | 63 |
| 22.2.4 | Communication Menu | 63 |
| 22.2.5 | Display Menu | 64 |
| 22.2.6 | Connections Menu | 64 |
| 23 | Description of Parameters | 64 |
| 23.1 | Setting the Measurement Place Parameters (Application Menu) | 64 |
| 23.1.1 | Name of Measurement Place | 65 |
| 23.1.2 | Channel Profiles | 65 |
| 23.1.3 | Sludge Level | 66 |
| 23.1.4 | 3D-Preview | 66 |
| 23.1.5 | Low-Flow Suppression | 66 |
| 23.1.6 | Energy Saver | 67 |
| 23.1.7 | Damping | 68 |
| 23.1.8 | Stability | 68 |
| 23.2 | Setting Parameters in h-Sensors Menu (in pump shaft) | 69 |
| 23.2.1 | h-Sensor Types | 69 |
| 23.2.2 | Definition of Measurement Ranges | 70 |
| 23.3 | Setting Parameters in v-Sensors Menu | 74 |
| 23.3.1 | Number of Flow Velocity Sensors | 74 |
| 23.3.2 | Sensor Types | 75 |
| 23.3.3 | Mounting position of v-Sensors | 75 |
| 23.3.4 | Weighting | 79 |
| 23.3.5 | Limiting the Velocity Evaluation | 79 |
| 23.3.6 | Data Transmission Rate | 80 |

| | | |
|-----------|---|------------|
| 23.4 | Inputs and Outputs (analog and digital) | 80 |
| 23.4.1 | Analog Inputs..... | 81 |
| 23.4.2 | Analog Outputs..... | 82 |
| 23.4.3 | Digital Inputs..... | 84 |
| 23.4.4 | Digital Outputs | 86 |
| 23.5 | Pump / Frequency converter | 89 |
| 23.6 | Diagnosis | 91 |
| 24 | Data Parameter Menu | 91 |
| 24.1 | Trend..... | 91 |
| 24.2 | Day Totals | 94 |
| 24.3 | USB stick | 95 |
| 24.4 | Data Memory (Internal)..... | 99 |
| 24.5 | Operating hours | 100 |
| 25 | System..... | 101 |
| 25.1 | Information..... | 101 |
| 25.2 | Language settings | 101 |
| 25.2.1 | (Operation) Language | 102 |
| 25.2.2 | Date Format..... | 102 |
| 25.2.3 | Units | 102 |
| 25.2.4 | Memory Units | 103 |
| 25.3 | Time/Date | 104 |
| 25.4 | Error messages | 105 |
| 25.5 | Service | 105 |
| 25.5.1 | Change (System) Password..... | 106 |
| 25.5.2 | Restart..... | 106 |
| 25.5.3 | Measurement Restart..... | 107 |
| 25.5.4 | Parameter Reset | 107 |
| 26 | Communication Parameters Menu | 107 |
| 27 | Display Parameters Menu..... | 109 |
| 28 | Connections | 111 |

| | |
|--|------------|
| DIAGNOSIS | 112 |
| 29 Basics of Diagnosis Menus | 112 |
| 30 Diagnosis h-Sensors | 112 |
| 31 Diagnosis v-Sensors | 113 |
| 32 Diagnosis Inputs and Outputs (analog und digital) | 114 |
| 32.1 Analog Inputs | 114 |
| 32.2 Analog Outputs | 115 |
| 32.3 Digital Inputs | 117 |
| 32.4 Digital Outputs | 117 |
| 33 Diagnosis Simulation | 119 |
| 34 Diagnosis Pump | 121 |
| MAINTENANCE AND CLEANING | 122 |
| 35 Maintenance | 122 |
| 35.1 Maintenance interval | 122 |
| 35.2 Customer Service Information | 122 |
| 36 Cleaning | 123 |
| 36.1 Transmitter | 123 |
| 36.2 Sensors | 123 |
| 37 Dismantling/Disposal | 123 |
| 38 Accessories | 124 |
| INDEX | 125 |
| CREDITS AND LICENSES | 128 |
| 39 List of references of the licenses and codes used | 128 |

General

1 About this manual



Note

READ CAREFULLY BEFORE USE!

KEEP IN A SAFE PLACE FOR LATER REFERENCE!

This instruction manual is an original instruction for the flow measurement transmitter NivuFlow Energy Saver and is for the intended use of the device. This manual is oriented exclusively to qualified expert personnel.

Read this instruction manual carefully and completely prior to installation and connection since it contains relevant information on this product. Observe the notes and particularly follow the warning notes and safety instructions.

Keep this manual in a safe place and make sure it is available for the users of this product at any time.

If you should have problems to understand information contained within this instruction manual either contact the manufacturer or one of the distributors for further support. The manufacturer cannot be held responsible for damage to persons or material due to incorrectly understood information in this instruction.

In case of selling the instrument this instruction manual shall be provided to the purchaser since it is a part of the standard delivery.

1.1 Applicable documentation

For the installation and operation of the complete system extra manuals or technical descriptions may be required apart from this instruction manual.

- Technical Instruction for Correlation Sensors and external Electronic Box
- Installation Instruction for Correlation and Doppler Sensors
- Technical Description for Ex-Separator Module iXT
- Technical Description for Multiplexer MPX
- Instruction Manual for i-Series Intelligent Sensors
- Technical Information USB HART Modem
- Technical Instructions NIVUS MODBUS TCP/RTU Application Interface for measurement transmitters of the series NivuFlow 5xx, 6xx and 7xx

These manuals are provided with the auxiliary units or sensors and/or are available as download on the NIVUS homepage.

1.2 Signs and definitions used



| Image | Meaning | Remark |
|---|-----------------------|---|
|  | (Action) Step | Action to be performed by you. Note the numbering of action steps. Observe the order of the working steps. |
|  | Cross-reference | Reference to further or detailed information. |
| >Text< | Parameter or Menu | Indicates a parameter or a menu that is selected or described. |
|  | Reference to document | Refers to an accompanying documentation. |

Table 1-1 Structural elements within the manual

1.3 Abbreviations used

Colour code for wires, single conductors and components

The abbreviations of colours, wire and components follow the international colour code according to IEC 757.

| | | | | | | | |
|----|-------|------|--------------|----|-------------|----|--------|
| BK | black | RD | red | TR | transparent | BU | blue |
| WH | white | GNYE | green/yellow | GN | green | YE | yellow |
| BN | brown | GY | grey | PK | pink | | |

2 Connections and user elements

2.1 Power supply

The connection for power supply is located on the lower part of the plug-in module X1.

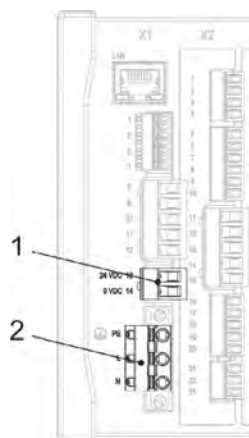

- 1 Power Supply DC
- 2 Power Supply AC and protective conductor

Fig. 2-1 Electrical connections of power supply



You can find a detailed connection plan in chapter „15.2 Plans of terminal connections“.

2.2 NivuFlow control elements

The NivuFlow is operated completely in dialogue mode supported by the graphs on the display. To select individual menus and sub-menus use the rotary pushbutton as well as the both function keys.

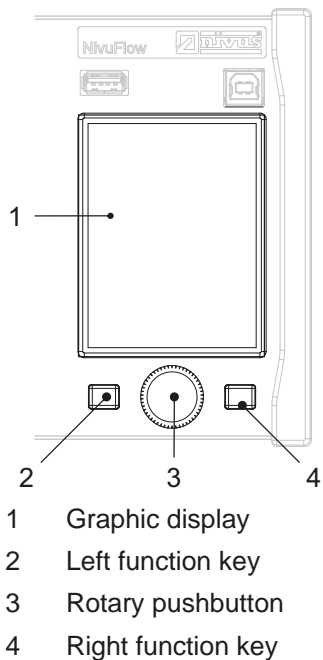

Fig. 2-2 Control elements

2.3 Tasks of control elements

Colour display

You can read all settings, when parameter setting and in diagnostics.

Left function key

Initially, this key takes you to the menu. They key is also used to exit menus or sub-menus.

Rotary pushbutton

Use the rotary pushbutton to enter specific sub-menus. The functions can be selected using the rotary pushbutton as well.

- Select the desired parameter or menus
- Navigation through the sub-menus and settings
- Selection of letters or numbers for parameter setting

Right function key

They key is used to confirm value entries (via numeric keys or letter keys).

For some parameters the right function key can be used as >TAB<. This TAB function is active only with the settings below:

- Main Display
- Menu >Application<
 - Selection of v-sensors
 - Diagnostics v-sensors
 - Selection of analog inputs (AI)
 - Selection of analog outputs (AO)

- Selection of digital inputs (DI)
- Selection of digital outputs (DO)
- Selection of pumps
- Diagnostics of pumps
- Menu >Data<
 - Selection of trend
 - Selection of day totals

While programming more than one input/output or more than one flow velocity sensor the right function key can be used to “jump across” from one input/output or sensor to the next one.



You will find a description on how to use the control elements in chapter „19 Operation Basics“.

2.4 Interfaces

The transmitter has several interfaces on the front panel.

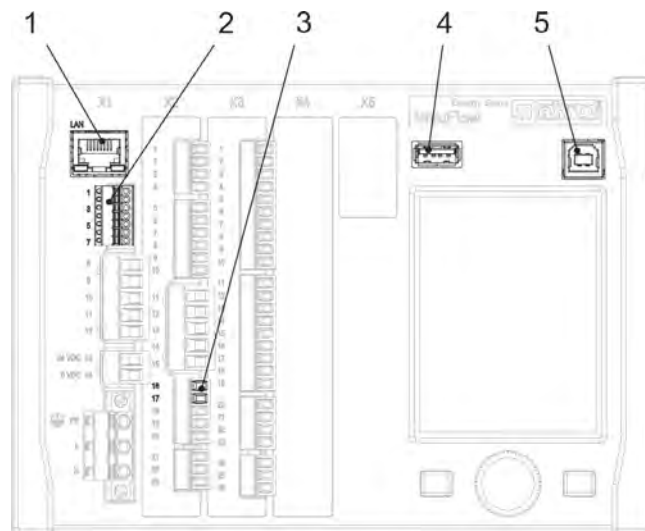

- 1 Network interface (LAN)
- 2 BUS interface (RS485/RS232)
- 3 HART-interface
- 4 USB-A-interface (data transfer, parameter backup, device update)
- 5 USB-B-interface (service mode)

Fig. 2-3 Available interfaces



Descriptions of the individual interfaces see chapter „26 Communication Parameters Menu“.

Safety Instructions

3 In general: Used symbols and signal words

3.1 Valuation of the accident level



The general warning symbol indicates the risk of personal injuries or death. In the text section the general warning symbol is used in conjunction with the signal words described below.

DANGER

Warnings in high degree of risk



Indicates a high-risk, imminently hazardous situation which will result in death or serious injury if not avoided.

WARNING

Warnings in medium degree of risk



Indicates a possible danger with medium risk which may result in a life-threatening situation or (severe) bodily injury if it is not avoided.

CAUTION

Warnings in low-risk or property damages



Indicates a possible danger with moderate risk which may result in minor or moderate personal injury or material damage if not avoided.

WARNING

Danger by electric voltage



Indicates a hazard with a high risk of electric shock which may result in a life-threatening situation or (severe) bodily injury if it is not avoided.



Important Note

Contains information that should be highlighted.

Indicates a potentially damaging situation which can result in a damage of the product or an object in its environment.



Note

Contains information and facts.

3.2 Warning notices on the product (option)



General warning label

This symbol is for operators to refer to this instruction manual.

Observing the information contained therein is required in order to maintain protection measures provided by the instrument during installation procedures and operation.



Protective conductor

This symbol refers to the protective conductor of the unit.

Depending on the mode of installation the instrument shall be operated solely connected to an appropriate protective conductor according to applicable laws and regulations.

4 Safeguards and Precautions

Working with NIVUS instruments requires to observe and to follow the safety measures and precautions below generally and at any time. These notes and warnings will not be repeated for each description within the document.

WARNING



Germ contamination

Please note that due to the operation in the waste water field the measurement system and cables may be loaded with dangerous disease germs. Respective precautionary measures must be taken to avoid damage to one's health.

Wear protective clothing.

WARNING



Observe occupational safety regulations

Before starting installation work, observing the work safety regulations need to be checked. Disregarding may lead in personal injury.

WARNING



Do not disable safety devices

It is strictly prohibited to disable the safety devices or to change the way they work. Disregarding may lead in personal injury or to a damage of the product.

WARNING



Danger by electric voltage

Maintenance, cleaning and/or repairs (by qualified personnel only) may only be performed when de-energised. Disconnect the systems from mains.

Disregarding may lead to electric shocks!



Important Note

The entire measurement system shall be installed and put into operation only by trained expert personnel.

5 Liability disclaimer

The manufacturer reserves the right to change the contents of this document including this liability disclaimer without prior notice and cannot be held responsible in any way for possible consequences resulting from such changes.

For connection, initial start-up and operation as well as maintenance of the unit the following information and higher legal regulations of the respective country (in Germany e. g. VDE regulations) such as applicable Ex regulations as well as safety requirements and regulations in order to avoid accidents shall be observed.

All operations on the device which go beyond installation or connection measures in principle shall be carried out by NIVUS staff or personnel authorised by NIVUS due to reasons of safety and guarantee.

Operate the transmitter only in technically perfect working order.

Improper Use

Not being operated in accordance with the requirements may impair the safety. The manufacturer is not responsible for failures resulting from improper use.

6 Use in accordance with the requirements



Note

The instrument is intended solely for the purpose described below.

Modifying or using the instruments for any other purposes without the manufacturer's written consent will not be considered as use in accordance with the requirements.

The manufacturer cannot be held responsible for any damage resulting from improper use.

The user alone bears any risk.

The permanent flow meter NivuFlow Energy Saver including the accompanying sensors is designed for continuous flow measurement of slight to heavily polluted media in full pipes in pump stations.

The flow meter is designed and manufactured in accordance with the current state of the art and with the recognised safety rules and regulations applicable at the time this document is issued. Danger to persons or material damage cannot be completely ruled out, however.

The maximum permissible limit values as specified in chapter „10 Specifications“ shall be necessarily observed. Any case varying from these conditions which is not approved by NIVUS GmbH in written form is left at the owner's risk.

Ex protection

In order to use flow velocity sensors in Ex areas ensure to install an Ex-Separation Module type iXT between transmitter and sensor.

For wiring diagrams refer to the according instruction manual/technical instruction (iXT0 resp. Correlation and Doppler Sensors).



Install the transmitter out of Ex zones!

The Ex approval of the sensors is part of the Technical Description and/or Instructions Manual.

The Ex approval of the Ex Separation Interface is part of the concerning Technical Description.



Conformity certificates and test certificates

For installation and commissioning the conformity certificates as well as the test certificates issued by the respective authorities shall be followed.

The combination of NivuFlow and the iXT Ex Separation Interface is adjusted solely to NIVUS sensors (correlation sensors, ultrasonic sensor OCL, i-series sensors i-03/i-06/i-10/i-15 and pressure probe NivuBar) regarding the intrinsically safe system review according to EN60079-25.

In the event of using sensors by third-party manufacturers the operator shall carry out a system review according to EN 60079-25!

The required specifications of the iXT Ex Separation Interface can be found in the according EC type examination certificate.

7 User's Responsibilities



Important Note

In the EEA (European Economic Area) national implementation of the frame-work directive 89/391/EEC and corresponding individual directives, in particular the directive 2009/104/EC concerning the minimum safety and health requirements for the use of work equipment by workers at work, as amended, are to be observed and adhered to.

In Germany e. g. the Industrial Safety Ordinance must be observed.

Make sure to have a local operating permit available and observe the associated conditions. In addition to this you must observe environmental requirements and local laws on the following points:

- Personnel safety (accident prevention regulations)
- Safety of work materials and tools (safety equipment and maintenance)
- Disposal of products (laws on wastes)
- Disposal of materials (laws on wastes)
- Cleaning (cleansing agents and disposal)

Connections

Operators shall make sure prior to operating the instrument that during installation and initial start-up the local regulations (such as regulations for electrical connection) are observed.

8 Personnel requirements

Installation, commissioning and maintenance shall be executed only by personnel meeting the demands as follows:

- Expert personnel with relevant training and appropriate qualification
- Personnel authorised by the plant operator



Qualified personnel

within the context of this documentation or the safety notes on the product itself are persons who are sufficiently familiar with installation, mounting, starting up and operation of the product and who have the relevant qualifications for their work; for example:

- I. Training, instruction or authorisation to activate/deactivate, isolate, ground, and mark electric circuits and devices/systems according to the safety engineering standards.*
 - II. Education and instruction according to the standards of safety engineering regarding the maintenance and use of adequate safety equipment.*
 - III. First aid training*
-

Product specification

9 Product construction and overview

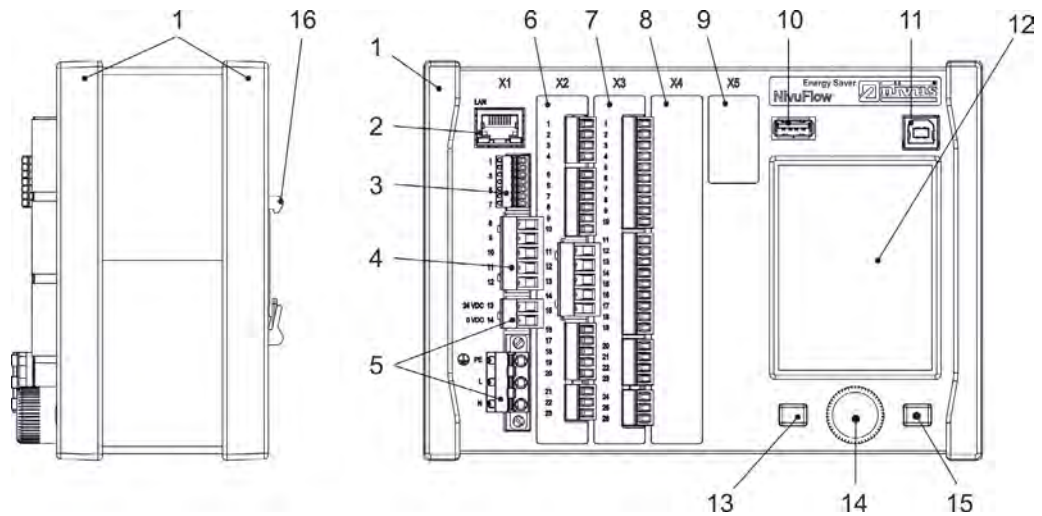

- 1 Trims/cover strips (only for installation in control cabinets)
- 2 Interface (LAN)
- 3 Bus interface (RS485/RS232)
- 4 Connection air ultrasonic sensor
- 5 Power supply
- 6 Plug-in X2 -
Non Ex: v-sensor 1, 2 and 3
Ex: connection of v-sensors via iXT, terminal 1...5
- 7 Plug-in X3 - Input/Output
- 8 Plug-in X4 - reserve (not wired)
- 9 Plug-in X5 - reserve (not wired)
- 10 USB-A-interface (data transfer, parameter backup, device update)
- 11 USB-B-interface (service mode)
- 12 Graphic display
- 13 Function key
- 14 Rotary pushbutton
- 15 Function key
- 16 DIN rail fastening

Fig. 9-1 Device setup NivuFlow Energy Saver enclosure type E0/E1



Note

For correct terminal wiring follow the terminal wiring diagram (see chapter „15.2 Plans of terminal connections“).

9.1 Dimensions of enclosure

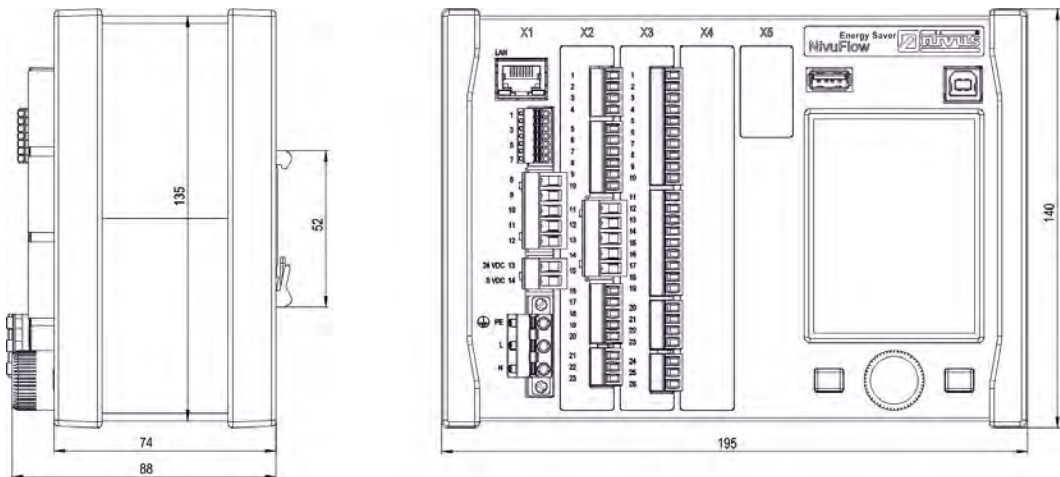

Fig. 9-2 Dimensions of NivuFlow enclosure type E0

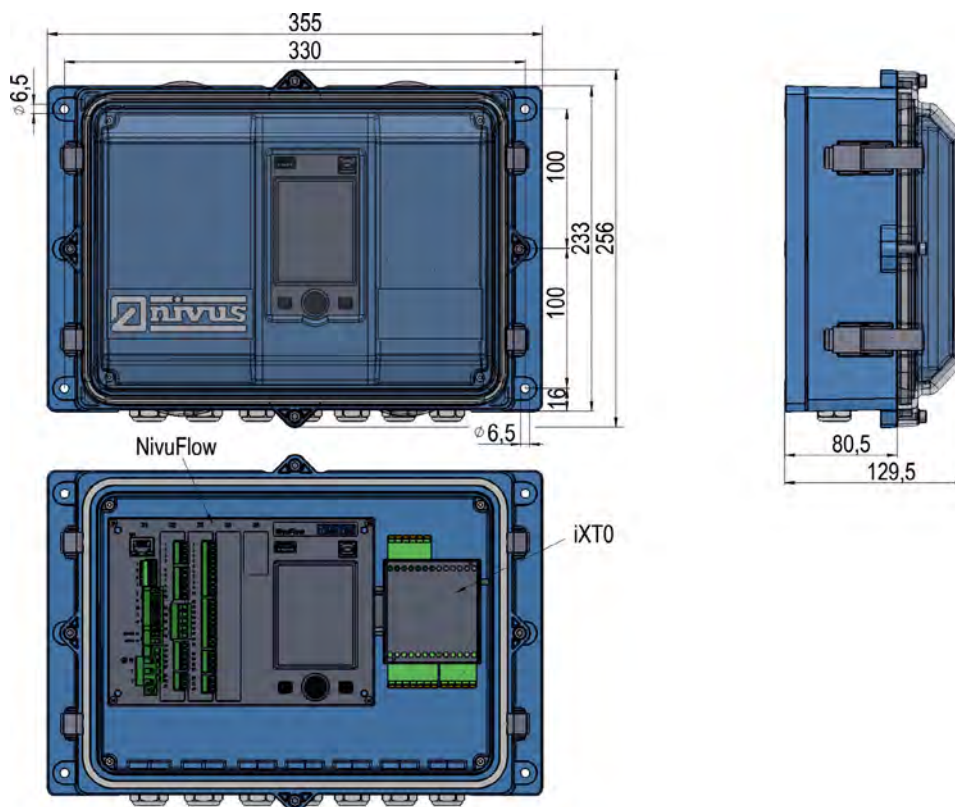
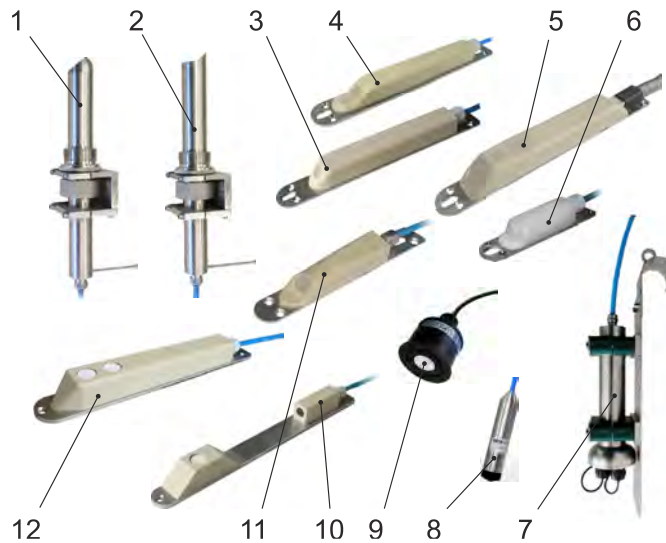

Fig. 9-3 Dimensions of field enclosure of NivuFlow with iXT

9.2 Connectable sensors

The image below provides an overview on the connectable sensors.



- 1 Pipe sensor, type CS2, with sensor screw connection and retaining element
- 2 Pipe sensor, type POA, with sensor screw connection and retaining element
- 3 Flow velocity sensor (wedge), type POA-V200/V2D0
- 4 Flow velocity sensor (wedge), type POA-V2H1/V2U1
- 5 Flow velocity sensor (wedge), type CS2
- 6 Mini flow velocity sensor (wedge), type CSM-V100
- 7 Electronic box, type EBM
- 8 Level-Pressure sensor, type NivuBar
- 9 i-series ultrasonic sensor NMI0, type i-03, i-06, i-10 and i-15
- 10 Ultrasonic level sensor, type DSM
- 11 Mini flow velocity sensor (wedge), type CSM-V1D0
- 12 Air ultrasonic sensor, type OCL-L1

Fig. 9-4 Connectable sensors

9.3 Device identification

The instructions contained within this manual are valid only for the type of device specified on the title page.

The name plate is fixed on the side of the enclosure and contains the following:

- Name and address of the manufacturer
- CE label
- Information on type and series, serial no. if available
- Power supply

In case of enquiries and ordering replacement parts it is important to specify article number as well as the serial number of the respective transmitter or sensor. This ensures correct and quick processing.



Note

Check the delivered instrument for accordance with your order by identifying the name-plate.

Check the nameplate for correct specification of the power supply.

 The declaration of conformity is located at the end of the manual.

Nameplates

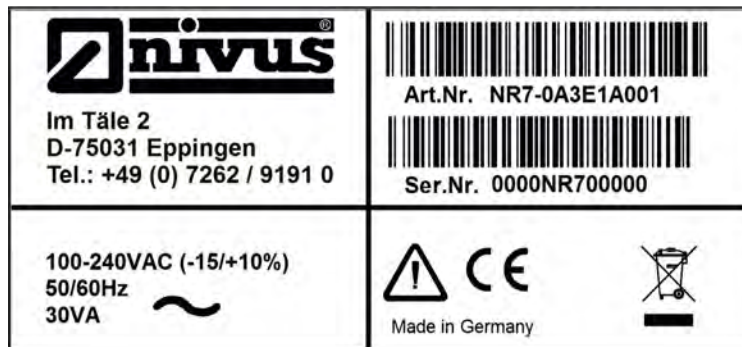

Fig. 9-5 Nameplate AC version



Fig. 9-6 Nameplate DC version

10 Specifications

| | |
|-------------------------------|--|
| Power supply | 100...240 V AC, -15 % / +10 %, 47...63 Hz or 10...35 V DC |
| Supply connection | Plugged and screwed tension clamp terminal block |
| Max. power consumption | AC: 30 VA / DC: 20 W |
| Typ. power consumption | For 1x POA-V2U1 + 1x i-sensor + 1 relay energised, + 1x iXT0/MPX AC: apparent power 14 W (rounded), effective power 6.5 W (rounded) DC: 6.0 W (rounded) |
| Enclosure | DIN rail Material: aluminium and plastic Weight: ca. 1300 g Field enclosure Material: polycarbonate PC Weight: ca. 3200 g (incl. NivuFlow and iXT0 211) |
| Protection | DIN rail IP20 Field enclosure IP67 (option IP68) |
| Operating conditions | Protection class I Overvoltage category II Pollution degree 2 |

| | |
|--|---|
| Altitude | AC unit for use in altitudes up to 3000 m above MSL. At relay voltages >150 V the use is restricted to an altitude of max. 2000 m (AC and DC units) |
| Operating temperature | DC: -20...+70 °C AC: -20...+65 °C |
| Storage temperature | -30...+80 °C |
| Max. ambient temp. for installation and operation | +50 °C |
| Max. humidity | 80 %, non-condensing |
| Display | TFT full graphic colour daylight display, 240x360 pixel, 65536 colours |
| Programming | Dialog mode using rotary pushbutton and two function keys, in English, German, French, Italian, Spanish, Portuguese, Swedish, Danish, Finnish, Polish, Hungarian, Romanian, Czech and Russian |
| Connection | Plug with spring-cage terminal clamps |
| Inputs | <ul style="list-style-type: none"> - 1x 4...20 mA for external level (2-wire probe) - 1x 4...20 mA for external level (2-wire probe; HART) - 1x NIVUS air-ultrasonic sensor type OCL - 4x 0/4...20 mA with 12 Bit resolution for external level, external controller setpoint and data storage of external units, accuracy $\pm 0,4$ % of measuring range final value (20 mA), load 91 Ohm - 7x digital input - 1x flow velocity sensor (POA, CS2) connectable OR 1x communications input for iXT0 |
| Outputs | <ul style="list-style-type: none"> - 4x 0/4...20 mA, load 500 Ohm, 12 Bit resolution, accuracy higher than $\pm 0,1$ % at 20 °C (higher than $\pm 0,4$ % at -20...+70 °C) - 1x bistable relay SPDT, maximum load 230 V AC / 2 A (cos φ 0,9), min. switching current 100 mA - 4x relay SPDT, maximum load 230 V AC / 2 A (cos φ 0,9), min. switching current 10 mA |
| Data memory | Internal 1,0 GB, for programming and readings memory; read-out via front-side USB stick |
| Storage cycle | 30 seconds to 5 minutes |
| Communication | Modbus RTU via RS485 |

Table 10-1 Specifications

Sensors

Observe the specifications of the according sensors as described in the respective instruction manuals or technical descriptions.

11 Configuration

11.1 Device Types

The NivuFlow is available in different versions which mainly vary in terms of the number of connectable sensors and programmable measurement sites. The article number can be found on the nameplate (see „Nameplates“ at page 22).

| | | | | | | | |
|---------------------------------------|-----------|--|----------|--|--|----------|----------|
| NR7- Transmitter type NivuFlow | | | | | | | |
| Construction | | | | | | | |
| | 0 | For permanent full pipes | | | | | |
| Type | | | | | | | |
| | A | I/O-Equipment, 7x DI, 5x DO, 5x AI, 4x AO | | | | | |
| Sensor connections | | | | | | | |
| | 3 | Up to 3x v-sensor connectable via iXT0/MPX | | | | | |
| Enclosure and construction | | | | | | | |
| | E0 | DIN rail/panel mounting (cabinet), IP20 | | | | | |
| | E1 | DIN rail, prepared for mounting into NIVUS field enclosure, type ZUB0 NFW0 | | | | | |
| Power supply | | | | | | | |
| | A0 | 100...240 V AC | | | | | |
| | D0 | 10...35 V DC | | | | | |
| Firmware extensions | | | | | | | |
| | 0 | None | | | | | |
| Number of measurement sites | | | | | | | |
| | 1 | 1 measurement site | | | | | |
| NR7- | 0 | A | 3 | | | 0 | 1 |

Table 11-1 Product structuring

11.2 Delivery

The standard delivery of the NivuFlow Energy Saver contains:

- A transmitter type NivuFlow Energy Saver corresponding to the shipping documents.
- The instruction manual including the certificate of conformity and approvals. It contains any relevant information on how to operate the NivuFlow Energy Saver.

Check additional accessories depending on your order and according to the delivery note.

11.3 Reception inspection

Check the packaging for visible damage immediately after receipt. Any possible damage in transit shall be instantly reported to the carrier. Furthermore a written report shall be sent to NIVUS GmbH in Eppingen.

Incomplete deliveries shall be reported in writing either to your local representative or directly to the NIVUS head office in Eppingen within two weeks.



Note

Mistakes cannot be rectified later!

11.4 Storing

Observe the minimum and maximum values on environmental conditions such as temperature and humidity according to chapter „10 Specifications“.

The NivuFlow shall be protected from corrosive or organic solvent vapours, radioactive radiation as well as strong electromagnetic radiation.

Always store the instrument in its original packaging.

11.5 Transport

Do not expose the system to heavy shocks or vibrations.

Use the original packaging for transport.

11.6 Return

In case of a required reshipment return the unit at customer cost to NIVUS GmbH in Eppingen using the original packaging.

Insufficiently franked shipments will not be accepted!

11.7 Installation of spare parts and parts subject to wear and tear

We herewith particularly emphasise that replacement parts or accessories not supplied by NIVUS moreover are not certified and approved by NIVUS too.

Installation and/or the use of such products hence may negatively influence predetermined constructional characteristics of the measurement system or even lead to instrument failures.

NIVUS cannot be held responsible for any damage resulting due to the use of non-original parts and non-original accessories.



You can find original manufacturer spare parts or accessories in chapter „38 Accessories“ and/or in the valid price list.

Functional Principle

12 Operating Range

The NivuFlow Energy Saver is a non-portable measurement transmitter for flow measurement in pump stations. The equipment is conceived preferably for measurements in slight to heavily polluted aqueous liquids with various compositions.

The system can be used in permanent full pipes featuring various dimensions.

NivuFlow Energy Saver is a special version of the NivuFlow 750 transmitter. It is for use in **pump stations featuring up to four pumps**, the output of which is controlled by using a **frequency controller**.

In addition to flow metering details the display shows the filling levels within the pump shafts as well as information on the energy consumption of pumps:

- Total energy consumption of pump station
- Energy consumption of individual pumps

NivuFlow Energy Saver tasks and benefits

- Flow metering
- Indication of filling levels in pump shafts
- Energy saving and information on energy consumption of the pump station

The energy consumption will vary depending on the pump frequency. By determining the ratio between energy consumption and flow performance it is possible to determine the optimum pump frequency.

In order to realistically review the energy efficiency of the pump station or individual pumps (max. four) it is necessary to have accurate values on flow and pump frequency available.

The NivuFlow Energy Saver records and indicates such values.

Information on the energy consumption of pumps and pump station is indicated as clear text or coloured bar graph on the display. The colours provide information on efficiency based on the traffic lights colour system.

Moreover it is possible to forward transmitter data to telemetry units and after that to a SCADA system.

Sensors

You can find an overview on **connectable sensors** in chapter „9.2 Connectable sensors“.

Using an iXT/MPX up to three POA or CS2 sensors can be connected simultaneously. Alternative, without iXT/MPX, one POA or CS2 sensor can be connected directly to the measurement transmitter.

The use of several sensors on a common measurement place supports the more accurate detection of flow velocities.

Frequency Converters

The NivuFlow Energy Saver can be used together with the following ABB frequency converters:

- ACQ 580
- ACS 800 (in preparation)
- ACQ 810 (in preparation)

- ACS 550 (in preparation)
- ACS 355 (in preparation)
- User defined



>User defined< limited use only

It is technically possible to use own, user-defined frequency converters, NIVUS, however, do not provide any support and do not accept any warranty claims.

13 Functional Principles

13.1 Flow Velocity Measurement



Note to the ultrasound reflection principle

The measurement method used for flow velocity detection is based on the ultrasound reflection principle.

Hence, it is indispensable for the system to work that there are particles in the water, which are able to reflect the ultrasonic signal sent by the sensor (dirt particles, gas bubbles or similar).

13.1.1 Ultrasonic Cross Correlation

The piezo crystal has a slope to the flow direction and operates as a flow velocity sensor. Here an ultrasonic burst with a defined angle is sent into the medium. All the particles in the measurement path (air, dirt) reflect a small amount of the ultrasonic signal. The result is a particular signal depending on shape and size of the particles.

Hence, the multitude of the reflected signals results in a reflection pattern (see Fig. 13-1). The piezo crystal receives this pattern again, which then is converted into electric signals and will be saved in a built-in digital signal processor (DSP).

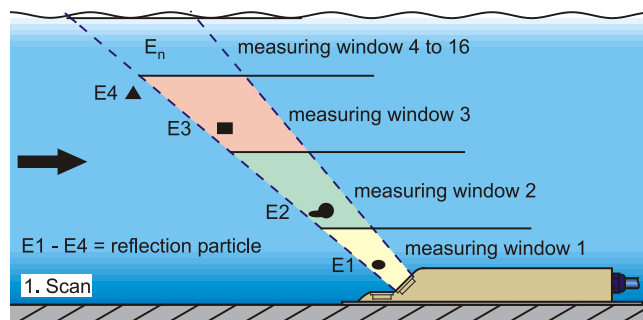

Fig. 13-1 Situation at first signal detection

After a certain period a second ultrasonic burst is sent into the medium. The newly generated reflection signal is saved in the DSP too.

In various flow levels there are different flow velocities (flow velocity profile).

Depending on the level, the reflecting particles' movement away from the first measurement point therefore varies. Hence, a distorted reflection pattern results (see Fig. 13-2).

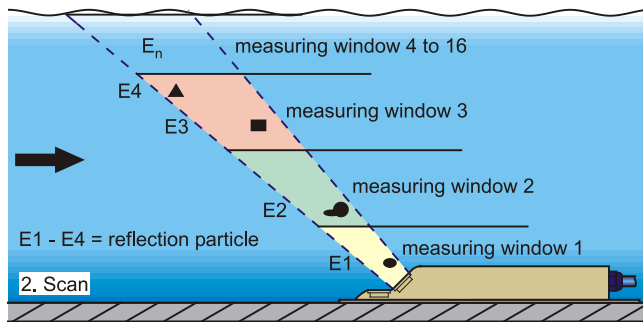

Fig. 13-2 Situation at second signal detection

The DSP checks both received reflection patterns for similarities using the cross correlation method. All existing signal differences (caused by new or rotated particles) are rejected so that two similar but temporarily offset signal patterns are left for velocity evaluation.

Depending on the flow levels both patterns are subdivided into 16 measurement windows. Then, in each measurement window the time shift Δt of the pattern is investigated (see Fig. 13-3).

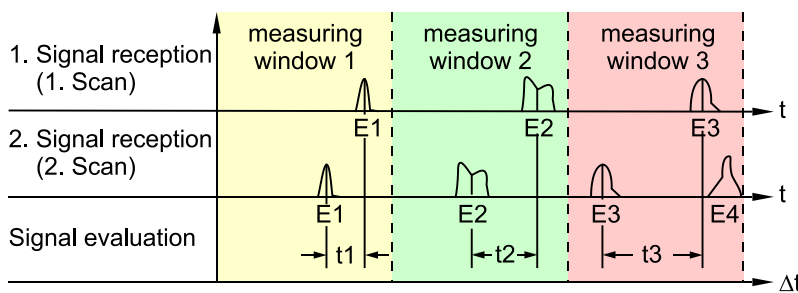

Fig. 13-3 Echo signal images and evaluation

Based on the beam angle, the interval between both transmitted signals and the shift of the signal pattern therefore in each single measurement window the flow velocity can be determined.

It mathematically strings the single flow velocities together which results in the flow profile of the acoustic path.

This velocity profile is indicated directly on the display of the NivuFlow.



Fig. 13-4 Determined flow profile

If a sufficient calming section is available on the measurement place it is possible to compute a 3-dimensional flow distribution (see Fig. 13-5).

The result is based on the geometric data of the flume and the velocity distribution.

In asymmetric flow profiles and heavily structured profiles it is recommended to use more than one flow velocity sensor. The entered sensor positions and the according individual vertical V-profiles are included with the overall 3D-profile and are indicated as well.

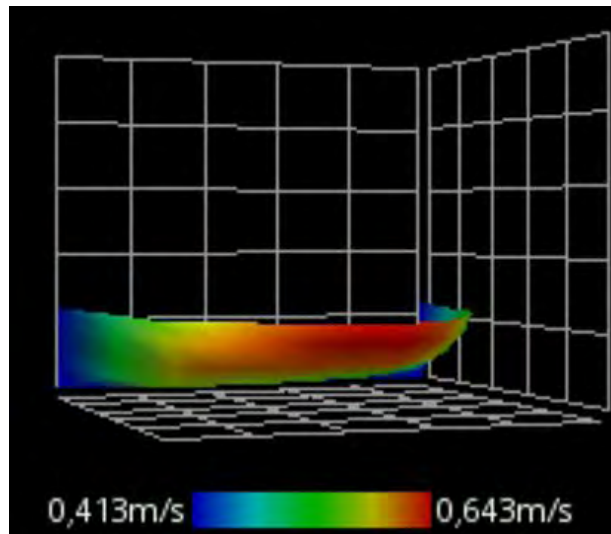

Fig. 13-5 Computed 3-dimensional flow profile

Taking this flow velocity distribution as a basis, the flow rate can be calculated and indicated by considering channel shape, channel dimensions and filling level. This flow rate is available as free programmable analog signal or as impulse signal on the transmitter output.

13.2 Level measurement in Pump Shaft

13.2.1 External level sensor

Depending on the selected type of level measurement an external 4...20 mA signal may be used for the level (e. g. by using an i-Series sensor).

It is possible to directly connect 2-wire sensors supplied by the NivuFlow Energy Saver (e. g. NivuBar, i-Series sensor). A 4...20 mA signal provided by an external transmitter (such as 4...20 mA from NivuMaster) can be used as well.

Installation and Connection

14 General Installation Instructions

During the installation, ensure that the following instructions regarding ESD and installation place.

- Follow applicable legal or operational guidelines.

Improper handling can result in injury and/or damage to the equipment.

14.1 Hints on how to avoid electrostatic discharge (ESD)



ESD risks

Maintenance procedures which do not require power supply of the instrument shall not be executed before the unit has been disconnected from mains power in order to minimise danger and ESD risks.

Disconnect the NivuFlow from mains power.

The sensitive electronic components inside the unit may get damaged by static electricity. The manufacturer recommends the following steps to prevent the device from getting damaged due to electrostatic discharge:

- Discharge static electricity from your body before touching the instrument's electronic components.
- Avoid unnecessary movements to reduce the risk of building up static electricity.

14.2 Installation and Mounting versions

The NivuFlow Energy Saver is available in two different mounting versions:

- Type E0 – for direct DIN rail mounting in control cabinets or similar enclosures
- Type E1 – special DIN rail mounting enclosure without cover stripe, with extended DIN rail fastening
 - Installation in NIVUS field enclosure ZUB0 NFW0 or ZUB0 NFW0 IP68
 - iXT Ex separation module or Multiplexer MPX can be installed within field enclosure additionally



Pre-assembled units with simultaneous order

As soon as NivuFlow Energy Saver Type E1, Ex Separation Module and the field enclosure are ordered simultaneously the units are shipped in pre-assembled condition and are connected to each other via bus cable.

CAUTION



NivuFlow Energy Saver Type E0 not suitable for installation in NIVUS field enclosure

It is not possible to install a NivuFlow Energy Saver Type E0 in a NIVUS field enclosure unless the transmitter is converted to a Type E1 unit. The conversion and the modification of connections can be carried out by NIVUS.

Later installation in NIVUS field enclosure

If a converted NivuFlow Energy Saver Type E0 transmitter and an iXT Ex separation module are to be installed in a NIVUS field enclosure, connect transmitter and iXT according to Fig. 14-1.

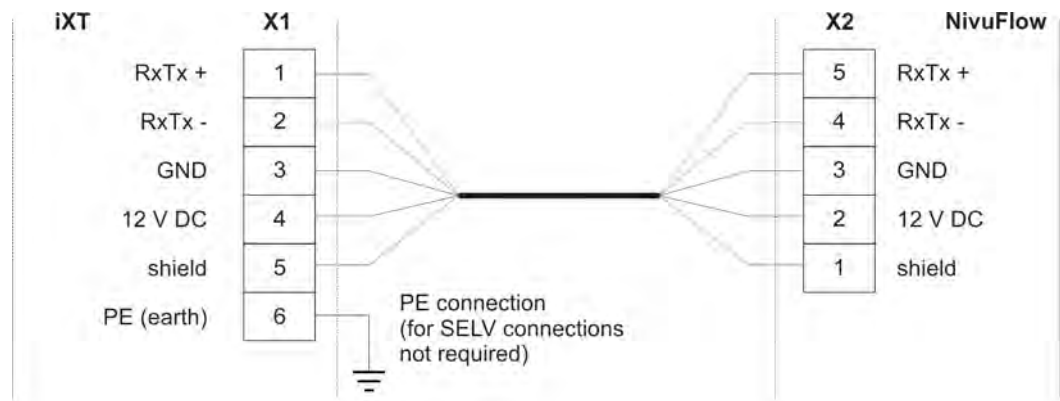

Fig. 14-1 Connection NivuFlow Energy Saver

When installing NivuFlow Energy Saver and iXT into the field enclosure observe the correct installation position which is given by the separation element on the inside of the enclosure cover. The transmitter display shall be placed in the centre of the cover window. Minor adjustments are possible by moving the unit on the DIN rail accordingly. The connection cable between iXT and NivuFlow Energy Saver shall be laid above the separation element.

14.3 Choosing the installation place

The NivuFlow with DIN rail fastening is conceived for installation in switching cabinets.

- ➡ Pay attention for adequate ventilation at the installation place, such as fans or air slits.
- ➡ During installation make sure that possibly existing separating devices (power switch) remain to be easily accessible.

It can be also installed in field enclosures or similar. Due to the protection degree, NivuFlow Energy Saver is not suitable to be installed directly on site without protective measures. To do so, use the optionally available field enclosure by NIVUS.

For safe installation on the mounting place make sure to take the following precautions:

- ➡ Protect the transmitter from direct sunlight. Install a sun shading if required.
- ➡ Avoid mounting the transmitter close to objects with strong electromagnetic fields (frequency converters, high voltage powerlines or similar).
- ➡ Observe the permissible ambient temperature (see chapter „10 Specifications“). If necessary install the transmitter in an air-conditioned control cabinet.
- ➡ Do not expose the transmitter to strong vibrations or mechanical shocks.

At the mounting place always avoid:

- Corrosive chemicals or gases
- Radioactive radiation
- Direct installation close to footpaths or travel ways

14.4 Transmitter fastening on DIN rail in control cabinets



Note

Mounting materials and tools are no part of the standard delivery.

- For fastening use a DIN rail type TS35 according to EN 50022 with a minimum length of 140 mm.
 1. Fasten the rail horizontally in the intended enclosure/switching cabinet by using at least two screws.
 2. Hook the transmitter into the DIN rail from below. The unit will snap in as soon as you exert slight pressure in the direction of the DIN rail.

Now you can begin to install the electric components and to connect the sensors.

14.5 Field enclosure fastening and preparing electric installation



Note

The fastening material is not part of the standard delivery but must be defined and chosen individually depending on the place of installation.

The NIVUS field enclosure can be installed permanently once the appropriate place of installation has been chosen. A basic condition is safe, durable and stable installation.

Required materials and auxiliary tools

- 6x screws M5, M6 or other screws sufficient for 6.5 mm diameter for proper fastening on surfaces (type and lengths of screws depending on material and quality of the surface)
- 6x dowels may be required (depending on material and quality of the surface as well as the screws used)

Preliminaries

- Procedure:
 1. Select fastening screws (type and length of screw) and accessories considering:
 - conditions and load capacity of the mounting surface (wood, metal, concrete, brickwork or similar)
 - required dowels or other auxiliary material

Tip:

When determining the length of the screws necessarily include the material thickness of approx. 17 mm of the mounting brackets.

2. If required drill dowel holes and insert the dowels.

Fastening the field enclosure

- Procedure:
 1. Fasten the field enclosure (Fig. 14-2 no. 3) on both lateral brackets by using the six previously selected screws through the fastening holes (6.5 mm diameter, Fig. 14-2 no. 6).

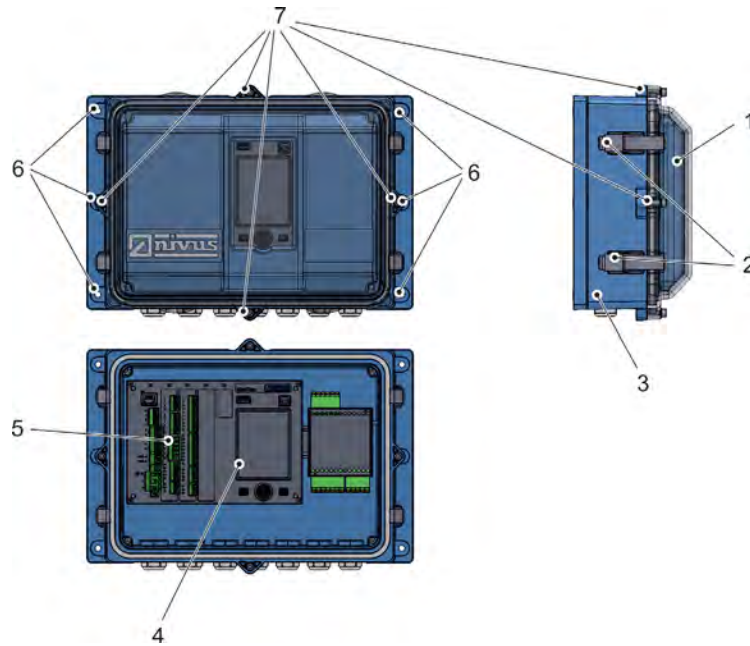

Fig. 14-2 Fastening the field enclosure

2. Remove the transport protection film from the clear view cover (Fig. 14-2 no. 1) if available.

Tip:

The protective film will harden upon exposure to UV radiation and possibly cannot be removed later without leaving any residue. Due to the changes to the protective film the readability may be strongly impaired.

New clear view covers can be purchased from NIVUS at extra costs and can be easily replaced by the user.

3. Install the weatherproof cover if available.

Preparing the field enclosure for electric installation

➡ Procedure:

1. To remove the clear view cover (Fig. 14-2 no. 1) from
 - enclosure type ZUB0 NFW0 (protection IP67):
Open the four lateral release clamps (Fig. 14-2 no. 2) and remove the enclosure cover.
 - enclosure type ZUB0 NFW0 IP68 (protection IP68):
Remove the four cylinder head screws M4x25 (Fig. 14-2 no. 7) including the washers, open the four lateral release clamps (Fig. 14-2 no. 2) and remove the enclosure cover.
2. To remove the blue inside cover loosen the four round head screws 3.5x25 in the corners and remove the cover. Now the transmitter including the display (Fig. 14-2 no. 4) and the terminal clamps (Fig. 14-2 no. 5) as well as the iXT are freely accessible.
3. Reassembly after electric connection is carried out in a reversed order. Here necessarily observe that
 - the gaskets are undamaged and free of dirt
 - the screws are tightened firmly
 Otherwise the IP67/IP68 protection rating **cannot be guaranteed**.

15 Electric Installation

WARNING



Danger from electrical current

Disconnect the unit from mains power.

Working on electric connections may cause the risk of electric shocks. Observe electric information provided on the nameplate.

Non-observance may result in personal injuries.



Note

Observe the national installation regulations.

☞ Make sure to take the following precautions:

1. Observe that the installation shall be carried out by qualified personnel only.
2. For electric installation the local regulations in the respective countries (in Germany e. g. VDE 0100) shall be referred to.
3. Further statutory standards (local), regulations and technical rulings have to be taken into account.
4. For installation in wet environments or in areas subject to flooding risk, extra protection such as by using a residual-current-operated protective device (RCD) is necessary if required.
5. Regarding Ex protection check whether the instruments power supply needs to be integrated into the facility's emergency shut-down concept.
6. Before feeding the rated voltage, transmitter and sensor installation must be correctly completed. Check that the installation is correct.



How to connect the sensors can be found starting at page 40, connecting the power supply is described on page 37.

15.1 Connection to the Terminal Blocks

All NivuFlow transmitters are equipped with push-in tension clamp terminals. The use of these push-in tension clamp terminals enables an easy pre-installation of the transmitter.

This allows verifying individual sensors, input and output signals etc. as well as easy transmitter replacement if required.

The tension clamp terminal blocks are suitable for the connection of single-wire and multiple wire copper cables. These cables are vibration-proof.



Important note

Unplug and connect the tension clamp terminal blocks only in de-energised condition disconnected from mains power.

☞ To open the contacts on the tension clamp terminal blocks, use gentle pressure with a slot screwdriver on the front-side orange elements.

To connect the power supply push-in and screw-type tension clamp terminal blocks are used.

To connect the power supply, use a slot screwdriver with a blade width of 3.0...3.5 mm.

WARNING



Danger from electrical current

Multiple wire cables (strands) of the AC power supply circuit as well as of relay connections shall be equipped with ferrules featuring an isolated protective collar (plastic ferrule) to avoid danger due to several protruding wires.

Non-observance may result in personal injuries.

| Tension clamp terminal block | Power supply | Bus/ Network | Terminals O/I etc. | Air ultrasonic sensor OCL-L1 |
|--|------------------------|---------------------|---------------------------|-------------------------------------|
| Wire cross section, rigid cables [mm²] | 0.2...2.5 | 0.2...0.5 | 0.14...1.5 | 0.2...2.5 |
| Wire cross section, flexible cable [mm²] | Only DC: 0.2...2.5 | 0.2...0.5 | 0.14...1.5 | 0.2...2.5 |
| Wire cross section (flexible) with ferrule blank [mm²] | Only DC: 0.25...2.5 | 0.25...0.5 | 0.25...1.5 | 0.25...2.5 |
| Wire cross section (flexible) with ferrule with plastic sleeve [mm²] | 0.25...2.5 | Undefined | 0.25...0.5 | 0.25...2.5 |

15.2 Plans of terminal connections

WARNING



Risk of electric shock

Do not remove the tension clamp terminal block from board X1 (connections 15...17).

This tension clamp terminal block is to connect the protective conductor as well as the AC power supply and is an integral part of the instrument. Operate the instrument with the tension clamp terminal block screwed on only.

Non-observance may result in personal injuries.

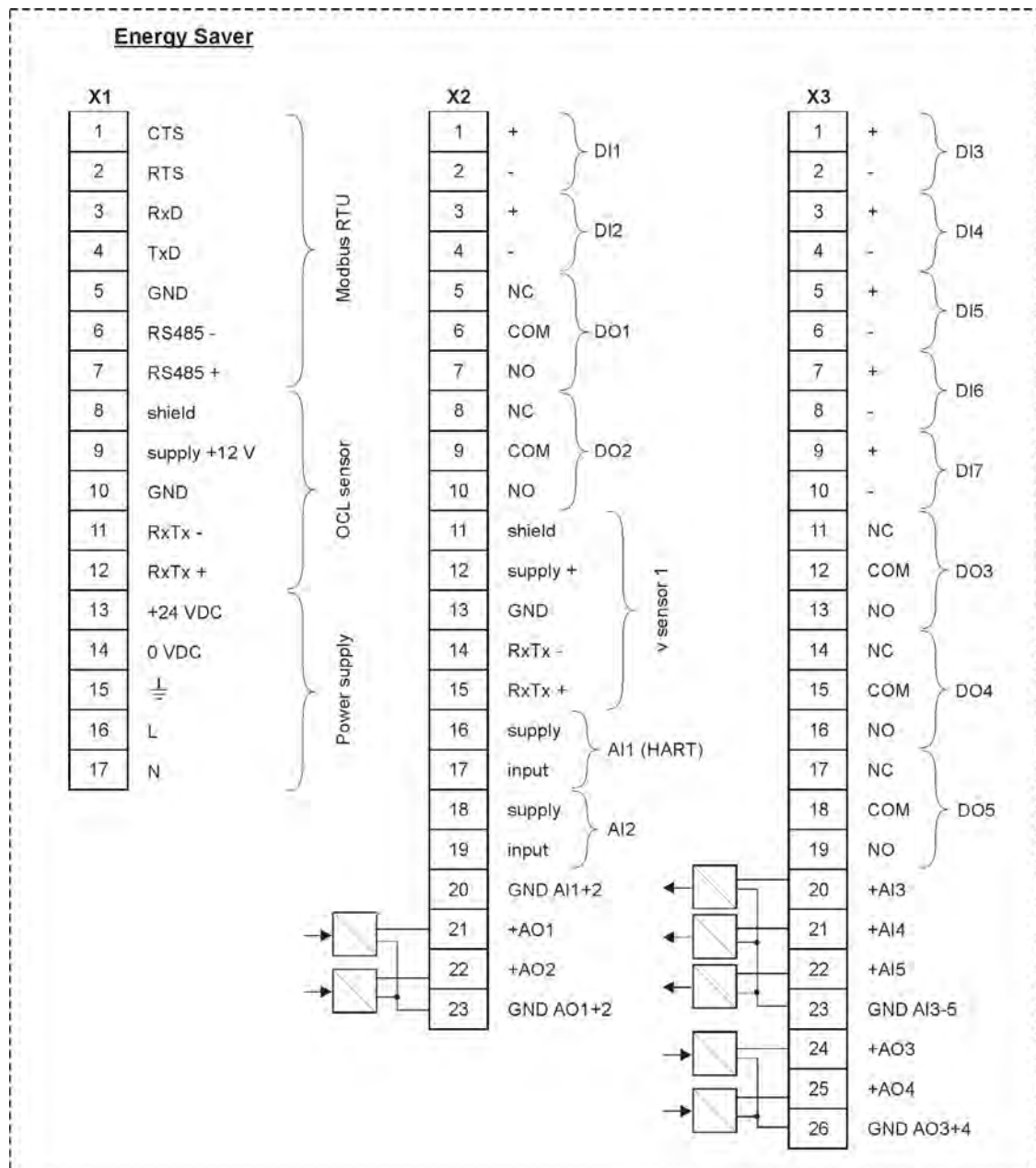
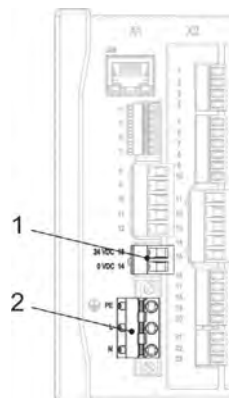

Fig. 15-1 Terminal connections NivuFlow Energy Saver

15.3 Switching on voltage supply

Depending on the type of NivuFlow used the unit can be powered with 100...240 V AC (-15 / +10 %) or with 10...35 V DC.



- 1 24 V DC connection
- 2 230 V AC connection

Fig. 15-2 Electrical Connections of power supply NivuFlow

WARNING



Risk of electric shock

Do not remove the tension clamp terminal block from board X1 (connections 15...17). This tension clamp terminal block is to connect the protective conductor as well as the AC power supply and is an integral part of the instrument. Operate the instrument with the tension clamp terminal block screwed on only. Non-observance may result in personal injuries.



Operation with alternating current - direct current

A transmitter with 24 V DC cannot be operated with alternating current. Further, it is not possible to operate a 230 V AC transmitter with 24 V direct current.

15.3.1 Power supply DC

The DC version can be directly operated from the 24 V direct current network of a control cabinet.

Requirements

- Input voltage available at the input clamps:
 - At maximum load (20 W) minimum 10 V
- Clamp voltage:
 - At no-load operation maximum 35 V

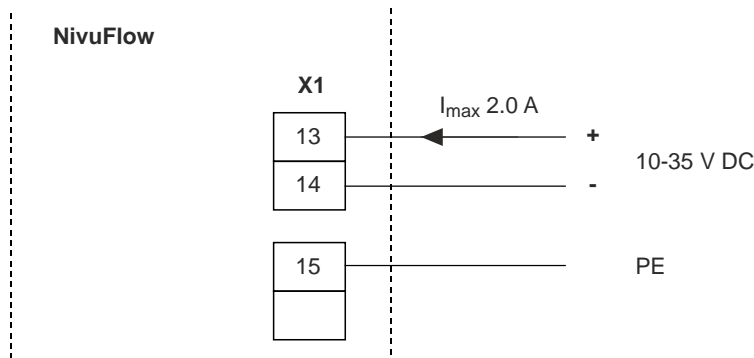

Fig. 15-3 DC connections of power supply

15.3.2 Power supply AC

WARNING



Danger from electrical current

Do not operate the unit if the terminal clamp blocks above the screw flange are not tightly screwed.

The terminal block X1 (connections 15...17) for connection of the earth conductor and AC power supply is an integral part of the device. It is no plug connection.

Non-observance may result in personal injuries.

WARNING



Danger from electrical current

The power supply must be separately protected by a 6 A slow-blow fuse and has to be isolated from other facility parts separate turn-off, e. g. by using an automatic cut-out with >B< characteristics). This separator should be marked conveniently.

Non-observance may result in personal injuries.

The AC version of NivuFlow can be directly operated from the low-voltage network.



The AC power supply requirements are described in chapter „10 Specifications“.

Requirements

- Cross-sectional dimension of the power supply wires:
 - Minimum 0.75 mm²
 - According to IEC227 or IEC245

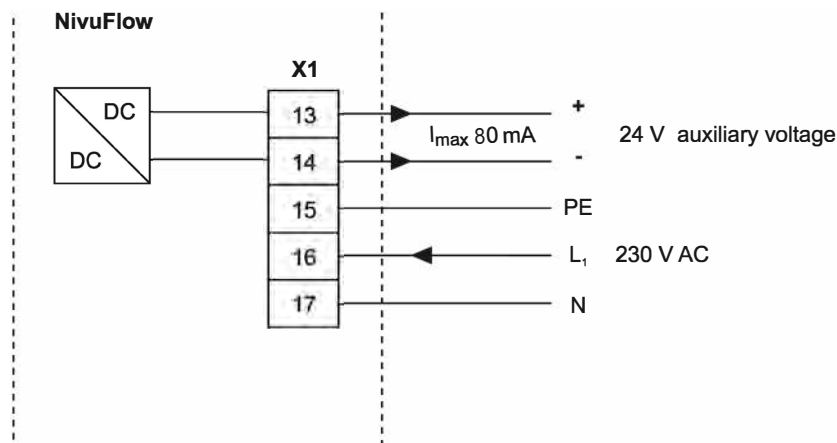

Fig. 15-4 AC connections of power supply

15.4 Relays

The reliability of the switching contact deteriorates if the minimum switching current is lower than specified.

- ⇒ Observe the connection and switching specifications of the relays in chapter „10 Specifications“.

WARNING



Danger from electrical current – Measures to prevent accidental contacts

Contact protection according to the requirements as specified in EN 61010-1:2010 is not guaranteed in the event of relay voltages >150 V due to the testing pin terminal of the relay clamp blocks.

Take all necessary protection against electrical shock according to the laws and regulations! For example: Open the cabinet/field enclosure only by the use of a tool or key, or use fault-current circuit breaker or similar.

Non-observance may result in personal injuries.

WARNING



Danger from electrical current – Protect Relay Contacts

The relay contacts of the instrument shall be protected using 6 A slow-blow fuses as soon as voltages in the low voltage range (such as AC supply voltages) are to be switched via the instrument's relay contacts. Moreover these contacts shall be designed so as to be switched off independent from other circuit parts.

DC units shall be equipped with an appropriate protective earth conductor in order to avoid dangerous voltages or currents.

Non-observance may result in personal injuries.

16 Installation and connection of sensors

The installation of individual sensor types is described in greater detail in the according installation instructions.



Note

During mounting works ensure compliance with all regulations on safety at work.

16.1 Sensor Installation Principles

The placing of sensors is vital for the reliability and accuracy of measurement results. Therefore observe proper hydraulic conditions and appropriate calming sections on the place of installation. Sensor types as well as the respective fastening methods shall be determined individually depending on the measurement place.



Conditions on how to select calming sections and the installation of sensors are described in the according installation instruction.

16.2 Cable and cable lengths for sensor connection

Between sensor and transmitter (direct connection non Ex):

For the complete distance between the NIVUS sensors and transmitter type NivuFlow use the specified cable of NIVUS:

- LiYC11Y 2x1.5 mm² + 1x2x0.34 mm² + PA

The signal cable is not suitable for direct and permanent installation in ground. Use protective tubes or protective hoses with appropriate inner diameters if the signal cable is to be installed in ground, concrete or similar.

Maximum cable length:

- 150 m

Connections to iXT/MPX can be made by using the LiYC11Y 2x1.5 mm² + 1x2x0.34 mm² + PA NIVUS standard cable or a Type A2Y(L)2Y 10x2x0.5 mm² telephone cable.



Details and connection diagrams can be found in the iXT and MPX documentation:

- *Technical Description for Ex-Separator Module iXT*
- *Technical Description for Multiplexer MPX*

16.3 Connection of Intelligent Ex Separator Module iXT and Multiplexer MPX

Ex Separator Module iXT

The iXT serves as Ex separation module for Zone 1 between the sensors (Type POA-V2, CS2, OCL air ultrasonic sensor, i-sensor and the NivuBar series) and the NivuFlow transmitter.

The sensors here necessarily need to be approved for use in Ex zones 1 or 0:

- Zone 1:
POA-V2, CS2, OCL air ultrasonic sensor and NivuBar series
- Zone 0:
i-sensor



Hints on i-sensor

The i-sensor **Zone 1** is encapsulated and is connected **only directly** to the NivuFlow.

The i-sensor **Zone 0** is intrinsically safe and shall be connected **only** to the iXT Ex separation module.



Ex Approval and EC Type Examination Certificate

The Ex approval is only valid in connection with the respective indication on the iXT enclosure nameplate.

The iXT Ex version is matched to the NIVUS sensors regarding the assessment of intrinsically safe electrical systems according to EN 60079-25.

The required specifications for the Ex versions of the sensors can be taken from the EC Type Examination Certificates TÜV 03 ATEX 2262 or TÜV 12 ATEX 087812.

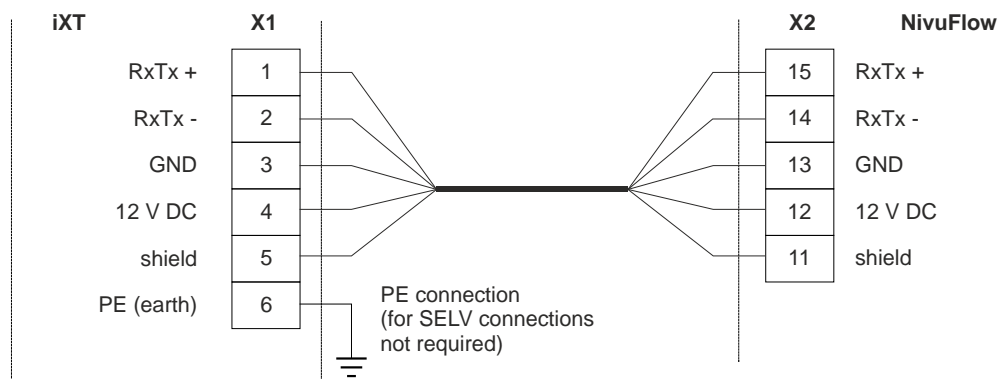

Fig. 16-1 iXT to NivuFlow Energy Saver



More detailed information on iXT, connection of varying sensors to iXT, overvoltage protection measures and similar can be found in the "Technical Description for iXT0 Ex Separation Module".

Multiplexer MPX

The Multiplexer MPX is an intelligent electronic module between one or more flow velocity and level sensors on site or in proximity of the sensors. It combines all sensor signals transmitting them to the NivuFlow transmitter through one single cable.

In combination with an auxiliary relay and an external power supply on site the MPX serves as line driver. By using an appropriate cable it is possible to achieve a distance of up to 1000 m between MPX and NivuFlow.

Sensors which can be connected to iXT can be connected to the MPX likewise. Ex approvals are not required here.

Moreover it is possible to apply a 4...20 mA level signal from an external transmitter.

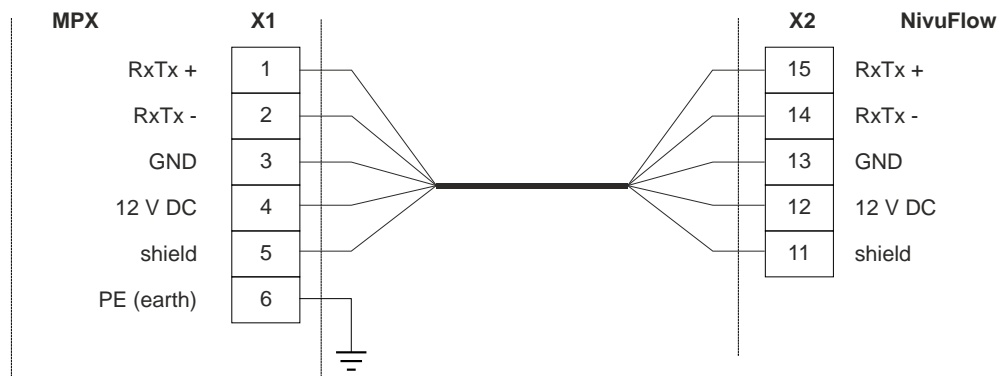

Fig. 16-2 MPX to NivuFlow Energy Saver



More detailed information on MPX, connection of varying sensors to MPX, overvoltage protection measures and similar can be found in the “Technical Description for MPX Multiplexer”.

16.4 Sensor Connection at NivuFlow

The connected sensors are used to

- Determine the flow velocity:
 - Using the connected flow velocity sensors
- Pump level determination:
 - Using the connected level sensors
 - Via Modbus
 - By defining a fixed value

16.4.1 Connecting flow velocity sensors

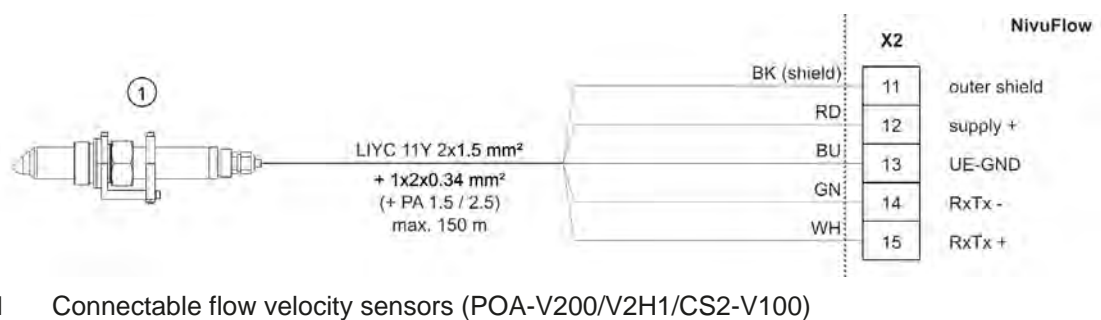

1 Connectable flow velocity sensors (POA-V200/V2H1/CS2-V100)

Fig. 16-3 Connection of flow velocity sensor to NivuFlow Energy Saver

16.4.2 Connection of level sensors

Air ultrasonic sensor OCL-L1

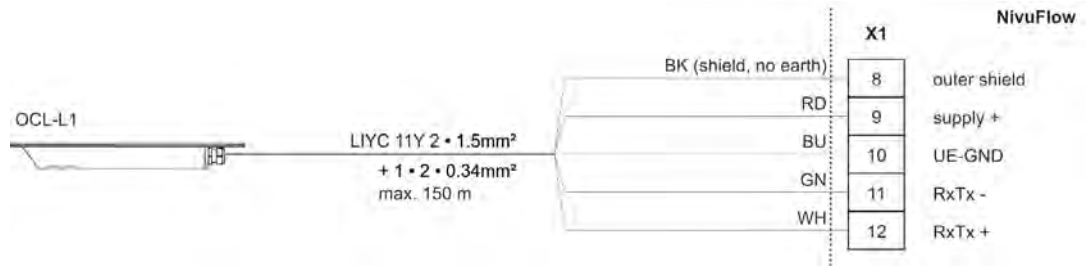

Fig. 16-4 Connection of air ultrasonic sensor type OCL-L1

2-wire sensor

The level measurement can (as an alternative to an integrated pressure cell) also be carried out by a 2-wire sensor (e. g. i-sensor, NivuBar) which is supplied by the NivuFlow.

- ➡ Connect the 2-wire sensor according to Fig. 16-5.



Fig. 16-5 Connection of 2-wire sensor for level measurement

- ➡ If the mA signal of the level measurement is provided from an external transmitter (e. g. NivuMaster), the transmitter must be connected according to Fig. 16-6.

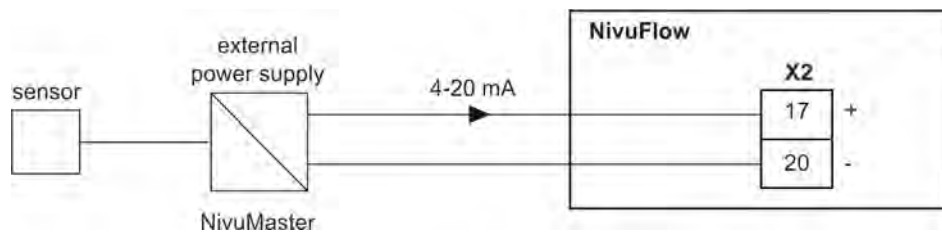

Fig. 16-6 Connection of an external level measurement

16.4.3 Special Points for Sensor Connection in Ex-Area Zone 1

- OCL sensor:
connection only to iXT Ex Separation module
- 4...20 mA signals from external transmitters:
connection to NivuFlow
- i-sensors with Ex approval:
 - Zone 1:
only direct connection to **NivuFlow**, not to iXT Ex Separation module
 - Zone 0:
connection **only** to **iXT** Ex Separation module, not to NivuFlow

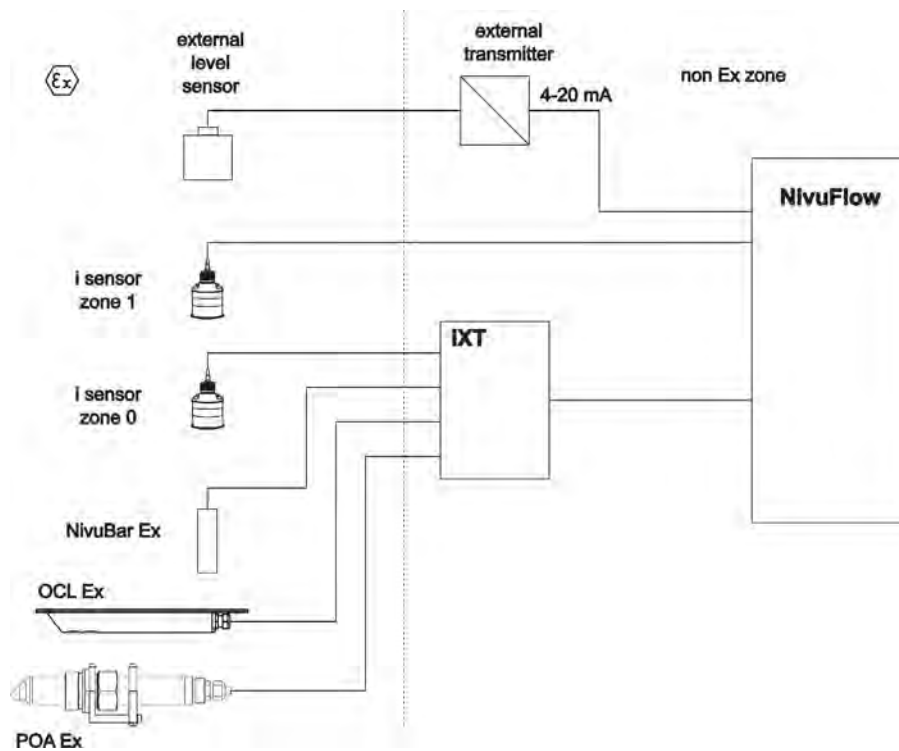

Fig. 16-7 Special points for connection in Ex zone 1

17 Overvoltage Protection

Due to being equipped with surge arresters in the power supply section and the sensor connection area the NivuFlow transmitter provides basic overvoltage protection. For effective protection of the NivuFlow transmitter it is necessary to protect power supply as well as mA-output using overvoltage protection devices.

NIVUS recommends surge arrestors types EnerPro 220Tr, EnerPro 24Tr (for 24 V C) for the mains supply, as well type DataPro 2x1 24/24Tr for mA-inputs and mA-outputs.

The flow velocity sensor as well as the air-ultrasonic sensor type OCL-L1 are internally protected against overvoltage. If higher voltages are expected to occur they can be protected by combining the types DataPro 2x1 12 V/12 V 11µH-Tr (N) as well as SonicPro 3x1 24 V/24 V.



Observe connection loads, capacity and inductance

If using the sensors in Ex areas consider the connected loads of the overvoltage protection devices as well as capacity and inductance of the NIVUS sensor cables (OCL-L1) additionally!

The maximum permissible NIVUS cable lengths in Ex areas are:

- Single-side overvoltage protection: 135 m
- Double-side overvoltage protection: 120 m



Reduction of the possible cable length

The use of overvoltage protection elements for sensors in Non-Ex areas will reduce the maximum possible cable length.

The line resistance is 0.3 Ohm/wire. This resistance must be taken into account considering the allowed total resistance (see Technical Instructions and/or Instruction Manuals of the sensors for details).

CAUTION



Observe the connection direction

Observe the non-reversed connection (p-side to transmitter) as well as a correct, straight wiring supply. Ground (earth) must lead to the unprotected side.

Do not switch the protected (p) and unprotected side of the overvoltage protection.

The overvoltage protection devices are ineffective if wired incorrectly.

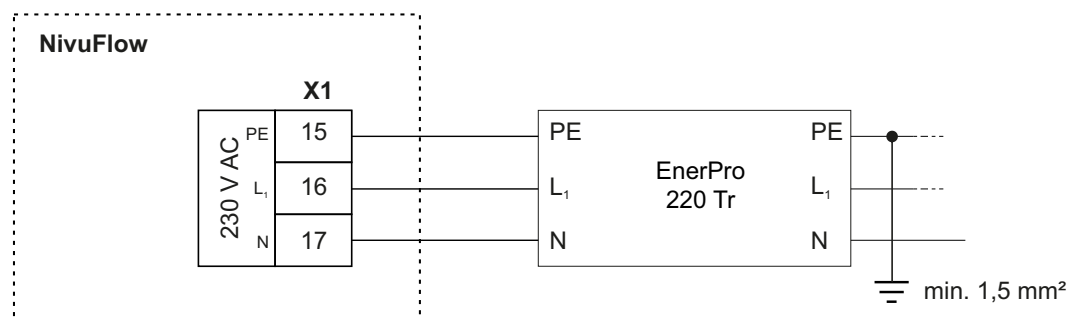

Fig. 17-1 Overvoltage protection for power supply AC

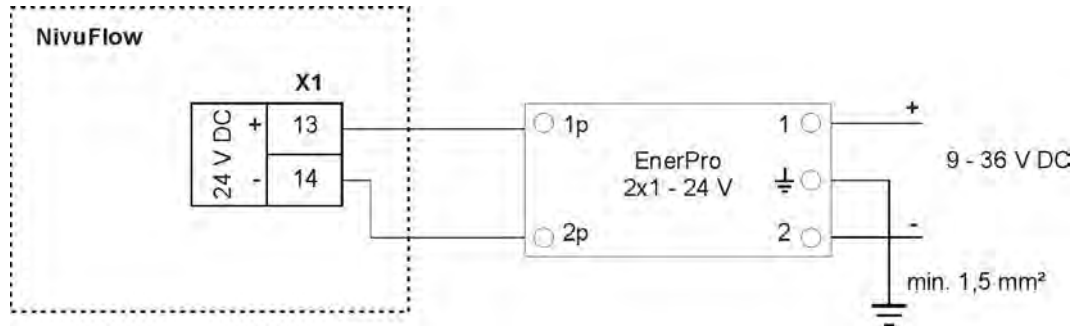

Fig. 17-2 Overvoltage protection for power supply DC

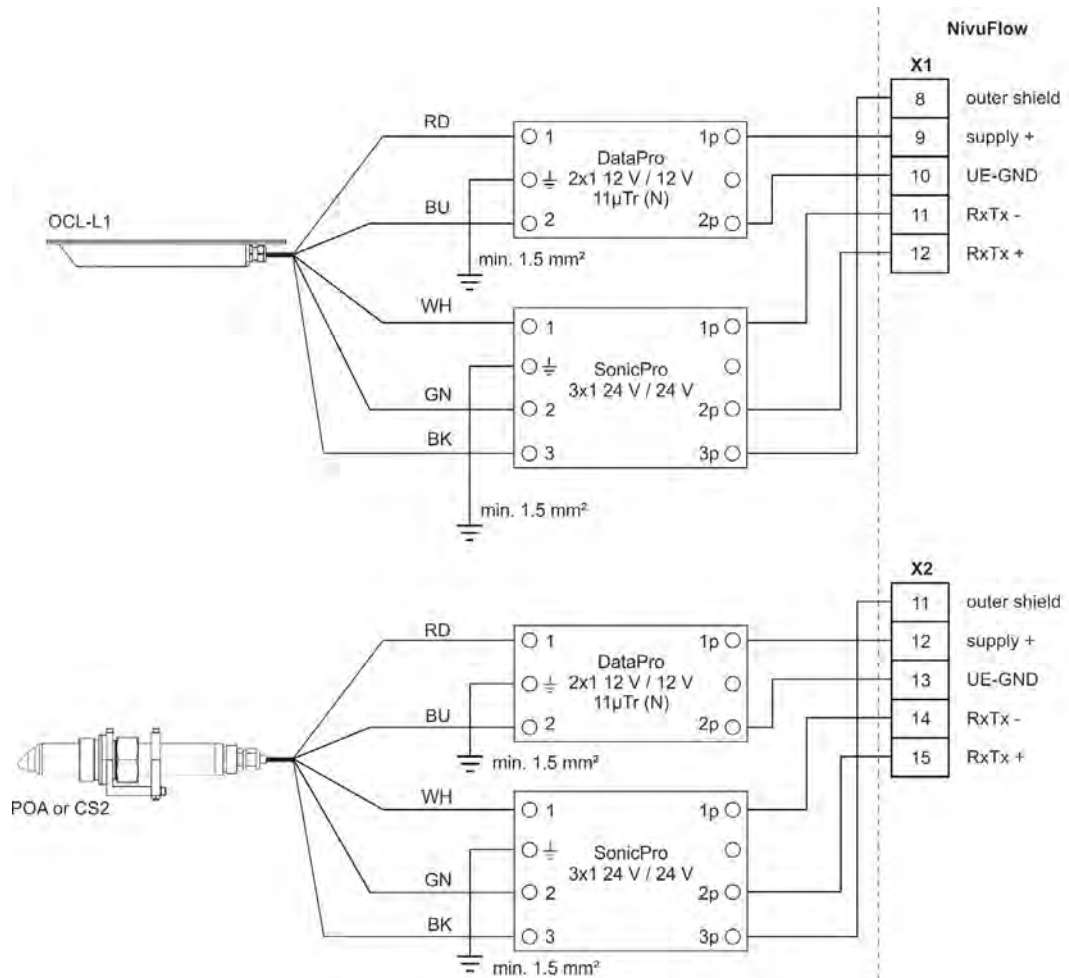

Fig. 17-3 Sensor overvoltage protection

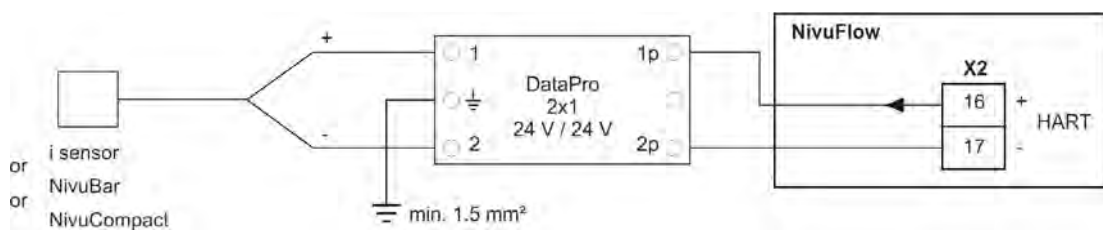

Fig. 17-4 Overvoltage protection external level measurement

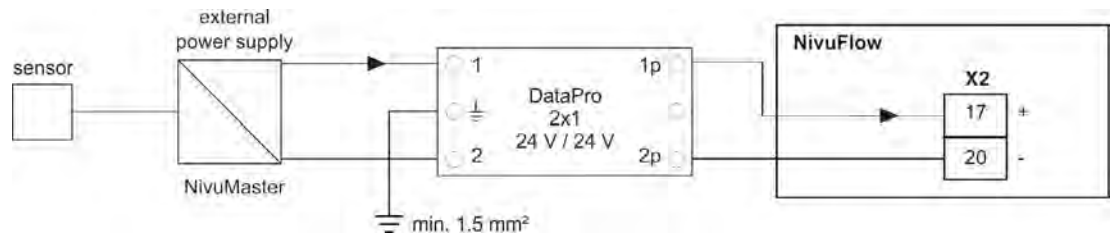

Fig. 17-5 Overvoltage protection of input from external transmitter

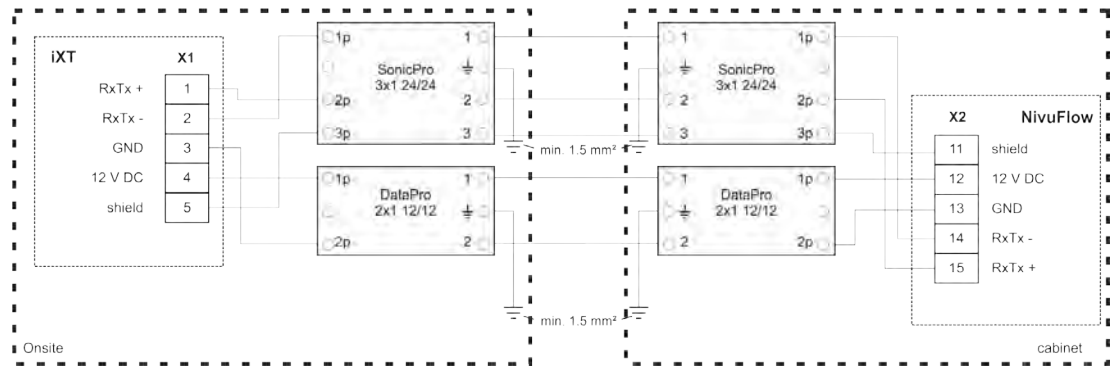

Fig. 17-6 Overvoltage protection iXT to NivuFlow Energy Saver



Notes on electrical discharge (grounding)

The minimum wire cross section is 1.5 mm² (not for strands).

The maximum permissible cable length is 1 m.

Operation start-up

18 Notes to users

Before connecting and operating the NivuFlow Energy Saver the instructions below shall be followed.

This instruction manual contains all information required for the setting of parameters and for the use of the instrument. The manual is intended for qualified personnel. Appropriate knowledge in the areas of measurement systems, automation technology, control engineering, information technology and wastewater hydraulics are preconditions for putting the NivuFlow into operation.

Read this instruction manual carefully in order to guarantee proper function of the NivuFlow.

The NivuFlow shall be wired according to the wiring diagram in chapter „15.2 Plans of terminal connections“.

In case of doubt regarding installation, connection or the setting of parameters contact our hotline:

- +49 (0) 7262 9191-955

General principles

The system shall not be put into operation before the installation has been finished and checked.

Follow the hints in the instruction manual to eliminate the risk of faulty or incorrect setting of parameters. Before you begin to set parameters, get familiar with the transmitter operation using rotary pushbutton, function keys and display.

The connection of transmitters and sensors (according to chapter „15.1 Connection to the Terminal Blocks“ and „16.4 Sensor Connection at NivuFlow“) followed by the setting of the measurement place parameters.

In most cases it is sufficient to set:

- Shapes and dimensions of the measurement place
- Sensors used and the according positions in the application
- Display units and language
- Span and function of analog and digital outputs

The user surface of the NivuFlow is easy to understand. Users can make all required **basic settings** themselves.

In case of the following requirements let either the manufacturer or an expert company authorised by the manufacturer set the parameters:

- Extensive programming tasks
- Difficult hydraulic conditions
- If the service specification requires a protocol on settings and errors
- Not specially trained qualified personnel or little experience in measurement systems

19 Operation Basics

The complete operation of the NivuFlow is handled via control elements (see chapter „2.2 NivuFlow control elements“). Two control buttons and one rotary pushbutton are available for the setting of parameters and to input required data.

The display at any time provides information on where you currently are within the menu structure and which entries you are about to modify.

19.1 Display Overview

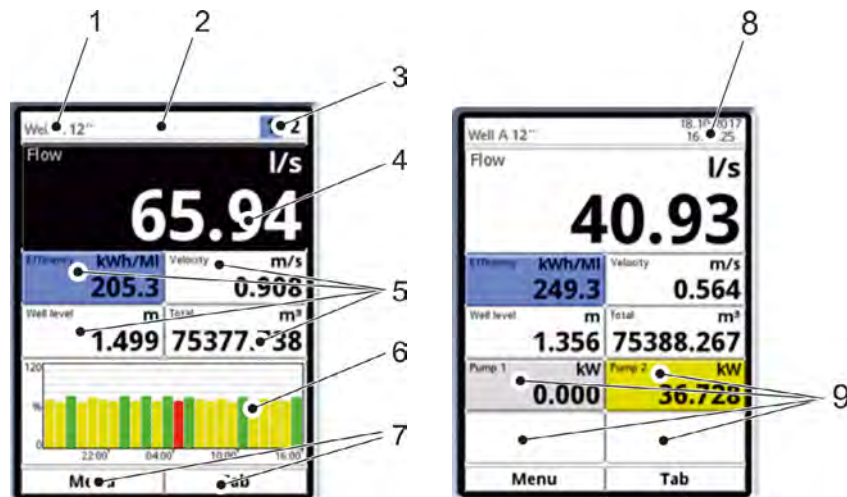

- 1 Name of measurement place
- 2 Error message sent, information or display for active service mode
- 3 Page or date/time
- 4 Output field: flow rate
- 5 Output fields: efficiency, average flow velocity, pump shaft level and total sum
- 6 Bar graph indication energy consumption and pump status of entire pump station
- 7 Function keys Menu/Tab
- 8 Date/time or page
- 9 Output fields for energy consumption of pumps 1...4

Fig. 19-1 Display overview

19.2 Using the Control elements

➡ First, select the >main menu<. Press the right hand function key.

1. Turn the rotary pushbutton to scroll through the menu. A sub-menu can be selected, as soon as it is highlighted blue.
2. Press the black part of the rotary pushbutton - you will get to the next parameter level or you can enter parameter settings.

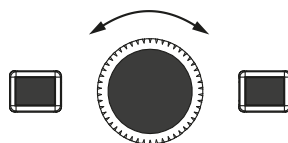

3. Repeat this process until you arrived at the desired menu or parameter.

Here you can enter names or numbers in parameters.

- ➡ See chapter „19.3 Use/Entry using the letter block“ and „19.4 Use/Entry using the numeric keypad“.

Press the left hand function key to exit the menus step by step.

The transmitter in the background operates with the settings which have been entered at the beginning of the parameter setting.

The following request is prompted on the display not before the current parameter setting has been finished and confirmed.



Fig. 19-2 Confirmation after parameter setting

- ⌂ Confirm the entry with >YES<.

The password query for the parameter settings appears:

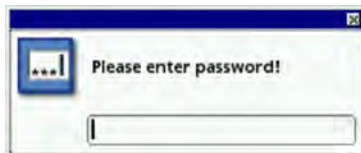

Fig. 19-3 Password query for parameter settings

- ⌂ Enter the password (default setting "2718").

After accepting the new parameters the NivuFlow continues to operate using these data.

19.3 Use/Entry using the letter block

Certain parameters can be labelled with names or designations. A virtual keypad is indicated in the bottom section of the display if such a parameter has been selected.

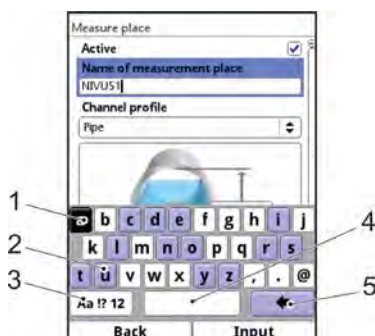

- 1 Selected character
- 2 Dual function character
- 3 Shift (upper/lower case)
- 4 Space
- 5 Back or delete button

Fig. 19-4 Keypad

**Note**

The use of the key pad is explained here one-time. Later in the manual you will be prompted to enter designations or names following this explanation.

A shift key can be found at the bottom left of the keypad (Fig. 19-4 no. 3).

- The functions of the shift key are:
 - Upper case
 - Lower case
 - Special characters
 - Digits
- These settings allow individual names of the measuring place almost without limitations.
- To **activate** this shift key rotate the rotary pushbutton until the shift key is highlighted black.



To **enter** designations such as the measurement place name proceed as follows:

1. Turn the rotary pushbutton to scroll to the lower half of the display. A virtual keypad featuring individually selectable letters is indicated.
2. Turn the rotary pushbutton to navigate through the virtual keypad. Characters highlighted blue (Fig. 19-4 no. 2) feature dual functions. Holding the button depressed for approx. 1 sec. switches over to alternative function.
3. Press the rotary pushbutton until the desired character is highlighted black. By pressing the character is applied to the text box automatically.
4. Repeat this process until the complete name is on the display.

19.4 Use/Entry using the numeric keypad

In certain parameters it is possible to enter dimensions or other numeric values. A number field (analogous to letter block) is indicated in the bottom section of the display if such a parameter has been selected.

**Note**

The use of the numeric key pad is explained here one-time. Later in the manual you will be prompted to enter dimensions or numerical values following this explanation.



Press the rotary pushbutton - a numeric field will appear:

1. Enter the values digit by digit. Proceed the same way as described before in the keypad section.
When entering the dimensions observe the correct decimal places. The channel profile dimension e. g. is set to METER per default.

If **multiple dimensions** shall be entered consecutively (e. g. for rectangular profiles), you can get to the next dimension by rotating the rotary pushbutton after your former entry has been confirmed. For the next entry proceed right as described before.

19.5 Revision of parameters

- Incorrect entry can be deleted letter by letter or digit by digit by pressing the back button:
 1. Open the keypad.
 2. Turn the rotary pushbutton until you get to the >back arrow< (back button).
 3. Press the rotary pushbutton - this will erase the wrong letter or number.
- Write subsequently until the complete name or dimension appears in the display and confirm the entry with the right hand function key.
The name of measurement or the numerical value is taken to the main menu and is displayed there.

19.6 Menus

All menus are described in a logical programming order in chapter „Setting Parameters“.

There are six basic menus available which can be viewed and selected by pressing the right hand function key.

The menus are:

| | |
|----------------------|---|
| Application | It guides the commissioning personnel through the entire setting of parameters for the dimensions of measurement places, selection of sensors and analog and digital inputs and outputs, pump functions and diagnoses. |
| Data | <ul style="list-style-type: none"> - Visually indicate charts on flow rate, level and (average) flow velocity - Visually indicate tables on 24-hour day totals - Save data - Save and load parameters - Format USB stick - Modify storage cycles and totals |
| System | <ul style="list-style-type: none"> - Recall basic information on the transmitter and the connected sensors such as serial no., version, article no. and many more (needed in the event of queries from the manufacturer) - Settings such as language, time and data format and units can be modified in the >country settings< - System time and time zones can be found in the >Time/Date< sub-menu - Error messages are available in the according sub-menu - Service level is not described in more detail here |
| Communication | This menu contains parameters for all communication interfaces available on the NivuFlow. |
| Display | <ul style="list-style-type: none"> - Basic parameters such as contrast, backlight and display dimming can be adjusted here - Format of the output fields (text, decimal places ...) can be set |
| Connections | <ul style="list-style-type: none"> - Possible connections for Ex-Separator Module/Multiplexer - Setting of Baud rate |

Main Display

Quick access

You can directly access the main setup parameters by using the Main screen.

20 General overview

The main display consists of two pages. Use the Tab key located right of the rotary pushbutton to browse through the pages. The page number is indicated in the top right corner for a few seconds once the Tab key is pressed.

Main Display

The following information can be found in the **top display line**:

- Name of measurement place
- Date (and at times the page number)
- Time

The red full circle with white cross (see Fig. 20-2) in the top display line indicates current malfunctions of system or individual sensors.

When in operation mode, the NivuFlow indicates the following important readings in the **main display sector**:

- Flow quantity
- Efficiency
- Velocity (calculated average flow velocity)
- Fill level shaft
- Total sum
- Pumps

A bar graph in the **bottom area** of the display provides information on efficiency and the function of both control keys as well. Instead of the bar graph, the second page provides information on the values of up to four pumps.

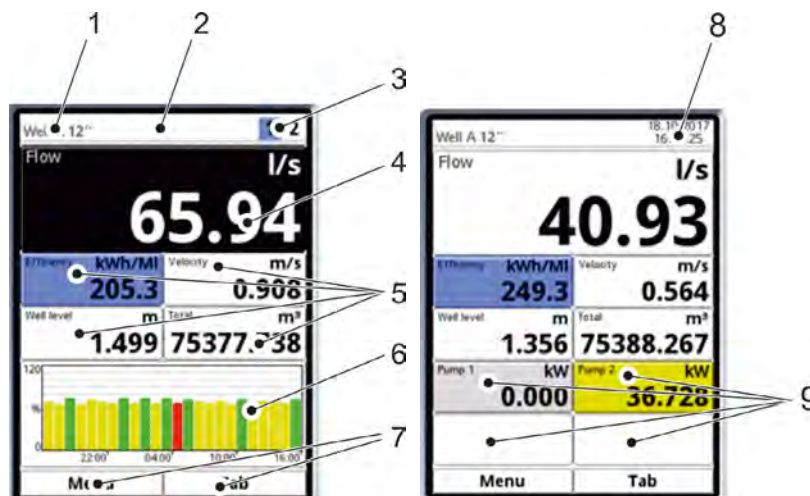

- 1 Name of measurement place
- 2 Error message (if pending) (see Fig. 20-2), information or display for active service mode
- 3 Page or date/time
- 4 Output field flow rate
- 5 Output fields: efficiency, average flow velocity, pump shaft level and total sum

- 6 Bar graph indication the relative efficiency [%] and pump status (colour of bar) of entire pump station
- 7 Function keys Menu/Tab
- 8 Date/Time or page
- 9 Output fields for the current energy consumption of the single pumps 1...4 and the concerning pump status (colour of bar)

Fig. 20-1 Main screen

The menu allows to directly access the most relevant settings and information.

- ➡ Rotate the rotary pushbutton until the desired section is highlighted in black.
- ➡ Press the rotary pushbutton - the according section will open a dialogue window.



Fig. 20-2 Flow volume section selected



Note

After having modified the system-specific parameters, you need to confirm that the modifications are saved to activate the modified parameters.

20.1 Display Flow

Once the dialog window has been activated by pressing the rotary pushbutton you can use the pop-up menu to access the individual menus (Settings, Diagnostics, Display and Error message; see chapter „23.1 Setting the Measurement Place Parameters (Application Menu)“, „27 Display Parameters Menu“, „25.4 Error messages“ and „Diagnosis“).

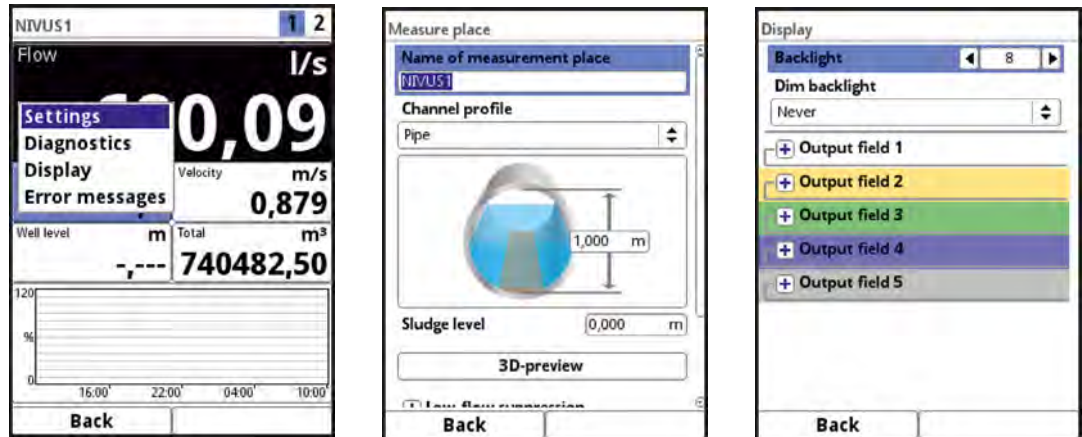

Fig. 20-3 Flow: Pop-up menu and pages

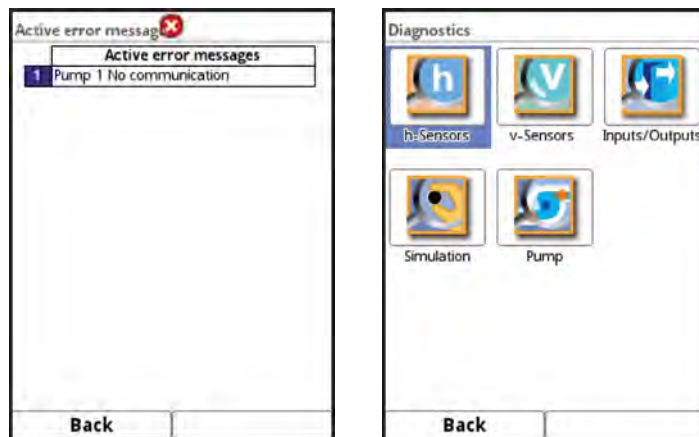

Fig. 20-4 Flow: pages

20.2 Display Efficiency

You can access the menu Display directly after the dialogue window is activated by pressing the rotary pushbutton (see chapter „27 Display Parameters Menu“).

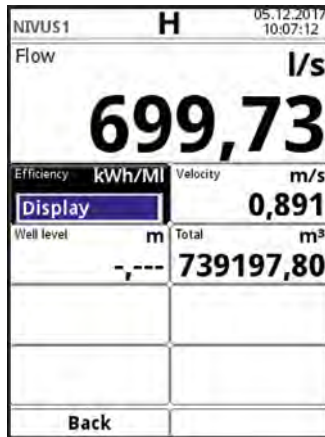

Fig. 20-5 Efficiency: Pop-up menu

20.3 Display Velocity

Once the dialog window has been activated by pressing the rotary pushbutton you can use the pop-up menu to access the individual menus (Settings, Diagnostics and Display; see chapter „23.3 Setting Parameters in v-Sensors Menu“, „31 Diagnosis v-Sensors“ and „27 Display Parameters Menu“).

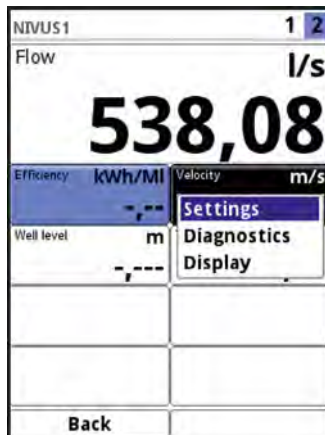

Fig. 20-6 Velocity: Pop-up menu

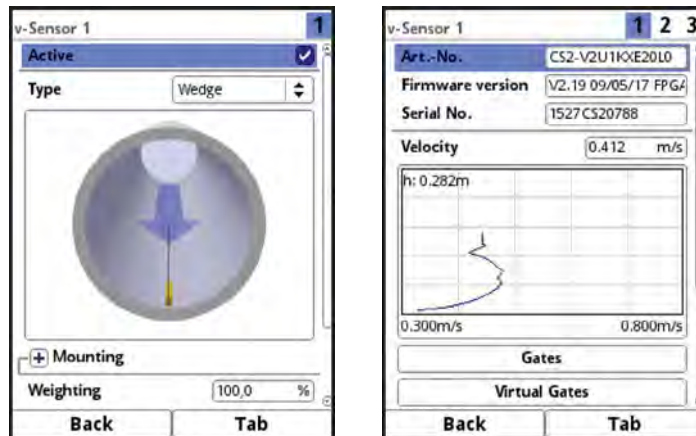

Fig. 20-7 Velocity: pages

20.4 Display Level Shaft

Once the dialog window has been activated by pressing the rotary pushbutton you can use the pop-up menu to access the individual menus (Settings, Diagnostics and Display; see chapter „23.2 Setting Parameters in h-Sensors Menu (in pump shaft)“, „30 Diagnosis h-Sensors“ and „27 Display Parameters Menu“).

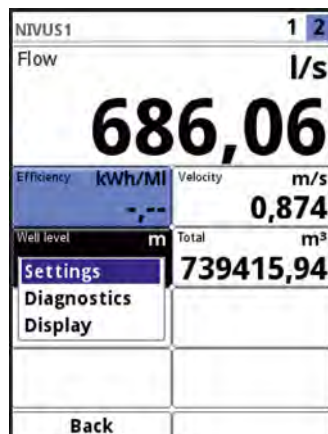

Fig. 20-8 Level Shaft: Pop-up menu

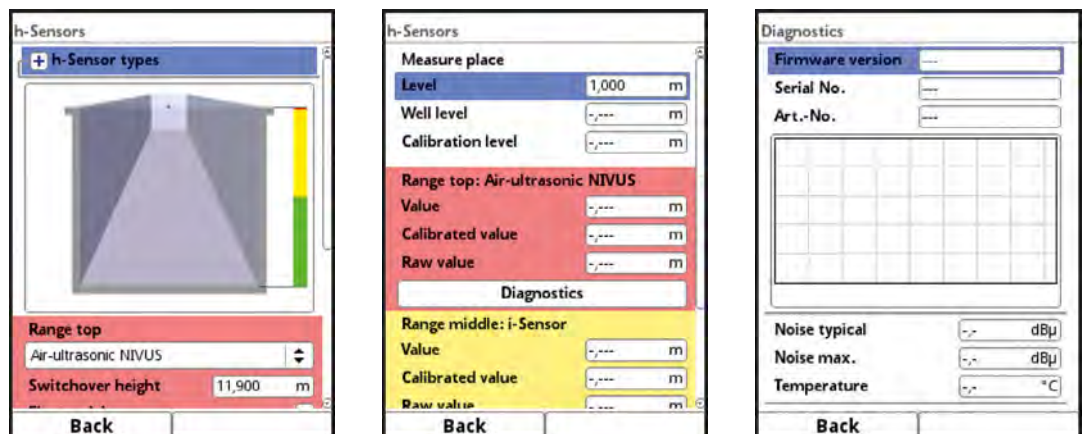

Fig. 20-9 Level Shaft: pages

20.5 Display Total

Once the dialog window has been activated by pressing the rotary pushbutton you can use the pop-up menu to access the display menu (see chapter „27 Display Parameters Menu“).

The **total** is calculated mathematically using the current flow volume integrated during a certain period. That is why both values neither can be edited nor can they be used for diagnostic options.



Fig. 20-10 Total: Pop-up menu

20.6 Display Pump (1...4)

Once the dialog window has been activated by pressing the rotary pushbutton you can use the pop-up menu to access the individual menus (Settings, Diagnostics, Display and Error Messages; see chapter „23.5 Pump / Frequency converter“, „34 Diagnosis Pump“ and „27 Display Parameters Menu“).

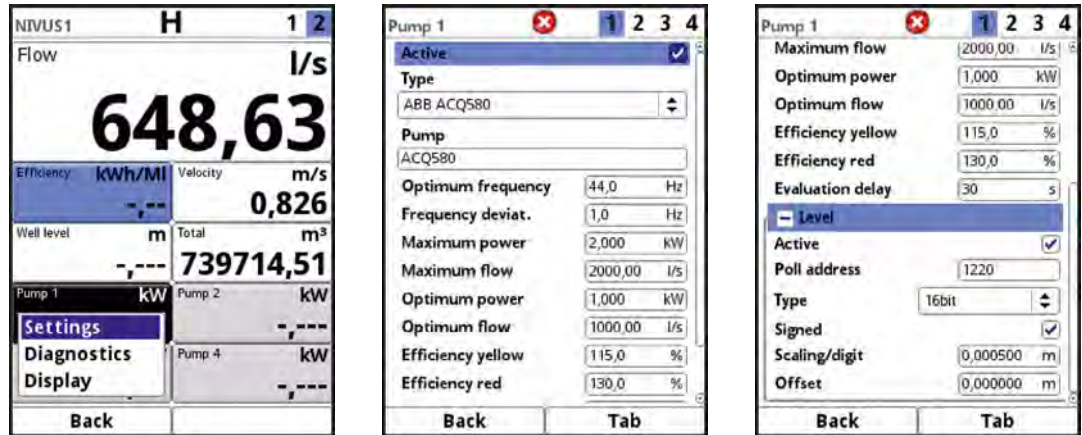

Fig. 20-11 Pump: Pop-up menu and pages

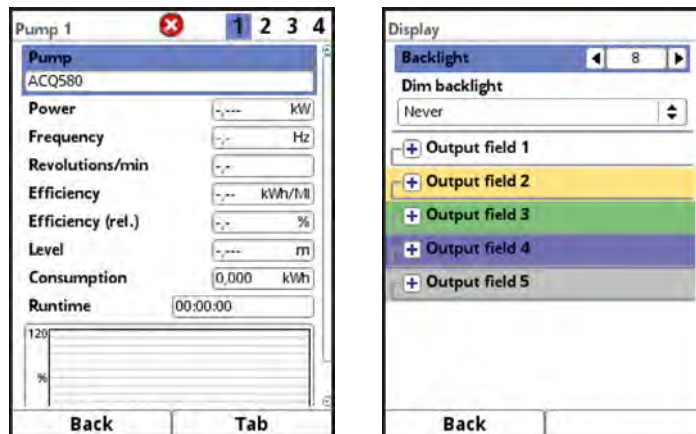

Fig. 20-12 Pump: pages

Setting Parameters

21 General Programming

As a principle modified parameters will not become effective before they have been saved. The transmitter will verify whether parameters have been modified while exiting any menu. Subsequently you will be prompted to decide if you wish to save the modified parameters.

- >Yes<: the modification will be accepted and saved.
- >No<: the modification will be rejected and the menu is exited.
- >Cancel<: You are exiting the prompt. Parameters remain to be modified but will not become effective and will not be saved, however.

21.1 Save Parameters

If you wish to accept and to save parameters you need to enter a valid password first.

Default setting: 2718

21.2 Change Password

⇒ See also chapter „25.5.1 Change (System) Password“.

You can change the default password at any time. However, keep in mind that a modified password will secure any modifications of the transmitter settings. Here the password length is limited to a maximum of ten characters.

➡ Procedure to change the password:

1. First open the >System< menu.
2. Select >Service< submenu.
3. Activate the field >Change Password<.
4. Use the number field to enter the current password.
5. Then enter the new password (ten characters max.).
The transmitter will accept the new password securing all transmitter settings.



Important Note

Share your password with authorised persons only!

If you should write down your password store it in a safe place.

Should your password get lost contact the NIVUS Hotline.

22 Parameter Functions

22.1 Main Menu

The transmitter parameters can be set using a total of six setup menus within the first menu level. Individual menus and the according submenus are explained in greater detail starting in chapter „23 Description of Parameters“.



Fig. 22-1 Overview main menu



While setting parameters observe chapter „19 Operation Basics“.

22.2 Functions Top Menu Level

22.2.1 Application Menu

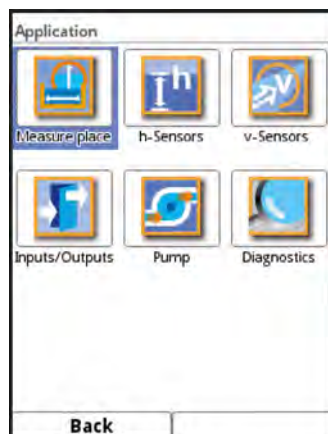

Fig. 22-2 Application Menu

This menu is the most extensive and most relevant when it comes to set the transmitter parameters. The >Application< menu contains six submenus. This is where shape and dimensions of the measurement site are to be set. The flow velocity sensors used as well as information on the mounting position are specified here.

Moreover the required analogue and digital inputs and outputs are defined here:

- Functions
- Measurement ranges
- Measurement spans
- Limit values

Data on the connected pumps can be shown and set here.

Within this menu diagnostic options for the items below are available:

- Sensors
- Inputs and outputs
- Pump
- Overall system

The diagnostic options are explained in chapter „Diagnosis“ starting at page 112.

22.2.2 Data Menu



Fig. 22-3 Data Menu

The >Data< menu allows accessing all measurement values in the internal memory.

The functions below are available:

- Graphic representation of measurement values
- List of the 100 previous 24h-day totals
- Communication and transmitting options of internal files
- Format external USB stick
- Transmission of parameters set from USB stick and back
- Options to set and to erase the internal data memory
- Setting the storage cycle
- Operating hours counter

22.2.3 System Menu

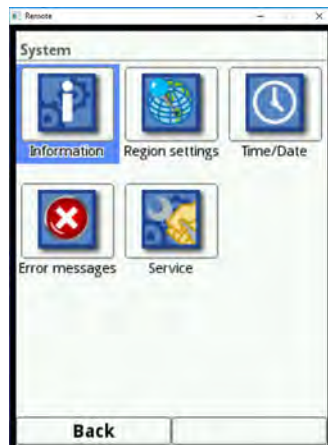

Fig. 22-4 System Menu

The >System< menu contains information on the transmitter:

- Article No.
- Firmware version
- Serial No.

Furthermore the settings/adjustments below are available:

- Set language
- Set units
- Adjust date and time
- Read active error messages
- Erase error memory
- Change password
- Restart (system or measurement)
- Parameter reset

22.2.4 Communication Menu



Fig. 22-5 Communication Menu

This menu comprises the settings for the communication of various communication interfaces with other communication systems:

- TCP/IP
- Webserver
- HART (in preparation)
- Modbus

22.2.5 Display Menu



Fig. 22-6 Display Menu

This menu permits to adjust the backlight settings as well as to adjust the settings of the five output fields of the main screen, if required.

22.2.6 Connections Menu



Fig. 22-7 Connections Menu

This is where the connection of the transmitter to the iXT intelligent Ex separation module and the MPX Multiplexer needs to be activated.

23 Description of Parameters

23.1 Setting the Measurement Place Parameters (Application Menu)

The >Measurement Place< submenu is one of the most important basic menus when it comes to parameter setting.

The following basic settings are required to set the parameters of the measurement place:

- Name of measurement place
- Type and dimensions of canal profile

- Sludge level
- Low-flow suppression
- Measurement damping and stability

23.1.1 Name of Measurement Place



Fig. 23-1 Entering the name of the measurement place

This is the place to enter the desired name of the measurement place. The name space is limited to 256 digits.

Default setting of the name: NIVUS1.

➡ Procedure:

1. Enter the name of the measurement place completely into the text field using the keypad.
2. Confirm the name by using the right function key "Input".
The name of the measurement place is accepted and will be indicated in the main menu.

23.1.2 Channel Profiles

The transmitter provides a selection of two profiles: pipe and rectangle.

Selecting the 3D preview will indicate the chosen profile graphically. The graphic representation shows the dimensional information entered in the correct proportions.

This visible aid permits to verify whether the profile has been created correctly in principle.

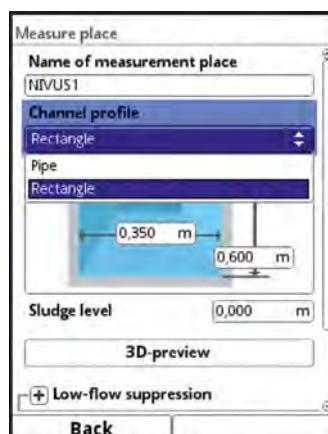

Fig. 23-2 Selectable channel profiles

- Select from the available channel profiles:
 - Pipe
 - Rectangular
- After selecting the profile enter the dimensions digit by digit. Observe the units (decimal places).
Default setting: channel profile dimensions in METER.

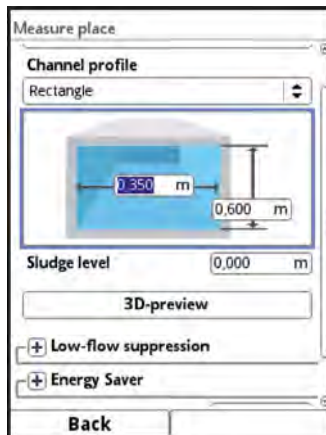

Fig. 23-3 Example of a channel profile menu

Pipe

This shape is suitable for round pipes.

Rectangular

This profile selection is used to set the parameters for canals with vertical walls and a horizontal bottom. The parameters can be set easily by simply entering width and height of the channel.

23.1.3 Sludge Level

In horizontal pipelines sedimentation may possibly occur on the channel bottom depending on measurement medium and the flow velocity.

This parameter can be used to specify a fixed level of sedimentation within the pipe as >Sludge Level<. The specified sludge level is calculated as "non-movable, partial surface of the channel with horizontal surface located on the bottom". This level will be subtracted from the wetted total hydraulic area prior to flow calculation.

23.1.4 3D-Preview

Selecting the 3D preview permits to indicate the configured measurement place including the according sensors.

23.1.5 Low-Flow Suppression

This parameter is to suppress very low movements or apparent flow volumes. The main area of use is the measurement of discharge volumes in permanently filled structures.

- Tick >Active<.
One more input option opens. Enter here the positive value you wish to suppress in case of lowest discharge. It is not possible to enter negative values here.

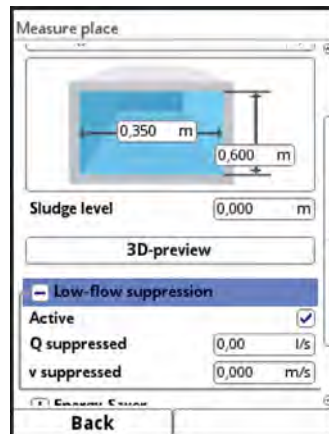

Fig. 23-4 Low-flow suppression

The low-flow suppression prevents the detection of lowest velocity changes. Over a long period such changes may cause high apparent fluctuations of the measured volumes.

Flow velocities lower than the value set above will be "suppressed" and hence are not detected as flow volumes. The transmitter does not save any values.

>Q suppressed<

- Enter a positive flow value. Negative values are not possible. The specified value is interpreted as absolute value and is effective as positive and as negative value.

The system will automatically set the measurement values to "0" as soon as the current calculated measurement values lower than this entered value.

>v suppressed<

This setting is to suppress low-flow volumes in applications with large profiles and high flow levels. Lowest velocity changes may cause high apparent volume fluctuations over a long period which cannot be hidden by using the >Q suppressed< parameter. As soon as the flow velocities are lower than the value of this parameter the system will set the values automatically to "0"

Hence the calculated volume is "0" too.

Only positive values are accepted. The specified value is interpreted as absolute value and is effective for positive as well as for negative velocities.

23.1.6 Energy Saver



Fig. 23-5 Energy Saver

This menu enables to adjust settings regarding the evaluation of energy consumption and the

energy efficiency of individual pumps as well as the entire pump station. The selected values are indicated as bar graph on the main display.

Moreover alarm messages are triggered using the settings here.

Values need to be entered necessarily in all subsections.

- **Level well max.**
Maximum possible level in (pump) shaft
- **Level pump start**
Level causing the pump to start
- **Consent flow**
Max. flow if all pumps are operated simultaneously
- **Critical high flow**
Critical flow rate in relation [%] to the expected flow rate; exceeding this value triggers an error message "critical high flow alarm"
- **Error cycles**
This is to set for the efficiency screen how many single errors (exceedance; from yellow to red) are required to output an error message.
- **Damping**
The damping setting will "smooth out" the values from the frequency converter: massive outliers are damped to enable evaluation based on realistic values exclusively. Entry is made in steps of 1 second.
- **Stability**
Stability is the gap the transmitter is able to bridge without receiving correct readings from the frequency converter (in case of communication errors or invalid values). During this period the transmitter operates using the latest valid reading. If the specified period expires without recording valid readings the transmitter goes to "0" considering the set damping value. No values will be saved. Entry is made in steps of 1 second.

23.1.7 Damping

This menu permits to modify the damping of display and analog output in seconds.

The damping relates to all level and flow velocity values available as input values. Individual values cannot be selected and damped differently.

All measurement values are saved covering the selected period and a floating average value is created for each individual measurement value. This average value will be used for the further flow rate calculation.

Entry is made in steps of 1 second.

Default setting: 30 s

23.1.8 Stability

Stability is the time gap without valid level and flow velocity values and hence without correct measurements bridged by the transmitter.

During this time gap the transmitter operates using the latest valid reading. As soon as the period specified here has expired without detecting a correct measurement value the transmitter will set the reading to "0" considering the damping value set. The transmitter does not save any values.

Entry is made in steps of 1 second.

Default setting: 30 s

23.2 Setting Parameters in h-Sensors Menu (in pump shaft)

After setting the measurement place parameters it is necessary to define the level sensor(s) used and to determine the according measurement ranges.

Level sensor parameters can be adjusted in the >h-Sensors< submenu.

23.2.1 h-Sensor Types

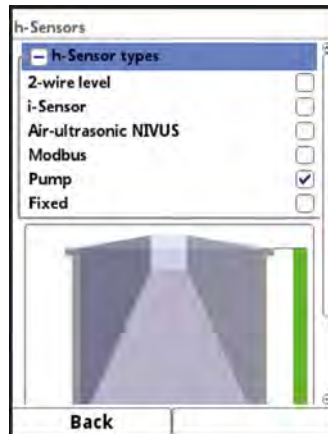

Fig. 23-6 Selecting the h-sensor types

In the >h-Sensor Types< field a selection of level sensors is available.

➡ Procedure:

1. Open parameter >h-Sensor Types<.
2. Select the sensor type connected to the transmitter.
In most cases it is sufficient to choose a level sensor.
3. If more than one level sensor is used (e. g. i-Sensor and 2-wire level) tick each sensor.



Note

In case a selected sensor has not been connected the transmitter recognises the missing or incorrectly selected sensor after finishing the parameter settings and will issue an error message.

The number of selected sensors is equal to the number of the selected level measurement ranges over the entire measurement cross section. Only one level sensor can provide a current reading per measurement. The transmitter does not accept incorrect and erroneous combinations.

A maximum of up to three different level sensors can be chosen.

The settings of the sensor measurement ranges can be adjusted below the channel graph.



Note

The transmitter does not recognize the type of 2-wire level sensor connected. This is why the sensor representation on the display is not relevant for the measurement range. Per default the transmitter will indicate the 2-wire level sensor on the display as ultrasonic sensor measuring from top down.

Example

Air-ultrasonic sensor on the top facing downwards; pressure sensor and water-ultrasonic sensor on the channel bottom.

The level sensors are indicated within the channel shape which has been set before in the measurement place parameters section.

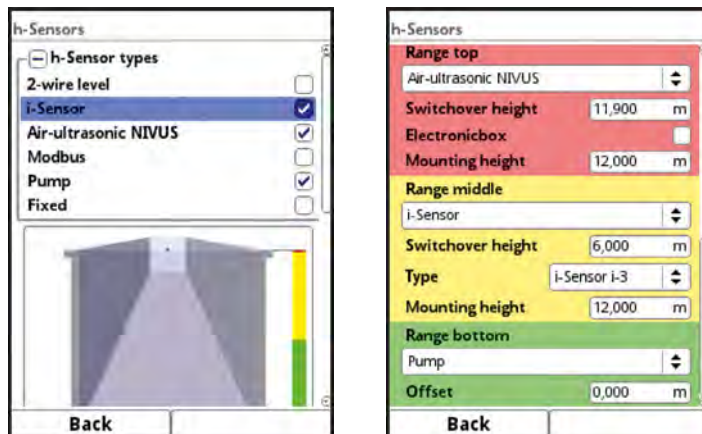

Fig. 23-7 Selecting the level sensors

Select from the following level sensor types:

- **2-wire Level**
Level measurement by using an external 2-wire sensor supplied by the transmitter.
Example: pressure probe type NivuBar Plus or compact echo sounder type NivuCompact.
Possible 0/4...20 mA-signals from an external transmitter such as NivuMaster or MultiRanger can be activated here too.
- **i-Sensor**
Connect ultrasonic i-Series sensors by NIVUS here. Connection is carried out via the HART interface.
- **NIVUS Air-Ultrasonic**
Level measurement from top down using an air-ultrasonic sensor type OCL-L1 or DSM-L0. Such sensors are used for measurement in low flow levels. The level sensor shall be installed in the centre of the channel crown ($\pm 2^\circ$) parallel to the water surface.
- **Modbus**
The connected Modbus master can be used to transmit the level which can be used then.
See also: "Technical Instructions NIVUS MODBUS TCP/RTU Application Interface for measurement transmitters of the series NivuFlow 5xx, 6xx and 7xx", chapter "Holding Registers".
- **Pump**
The (possibly available) level value can be retrieved from the frequency converter via Modbus.
- **Fixed Value**
The value can be set manually if there is no real value from the pump shaft available. The constant filling level is set as fixed value.
This parameter can be used as support for initial start-up or for test purposes without having level values available.

23.2.2 Definition of Measurement Ranges

A vertical coloured bar is indicated on the right-hand side of the channel graph depending on the type and number of selected sensors. This bar specifies the working area of the individual sensors using the according colour.

- Measurement range
 - Top: red

- Centre: yellow
- Bottom: green
- Number of sensors used
 - One sensor: solid green bar
 - Two: combination green/red

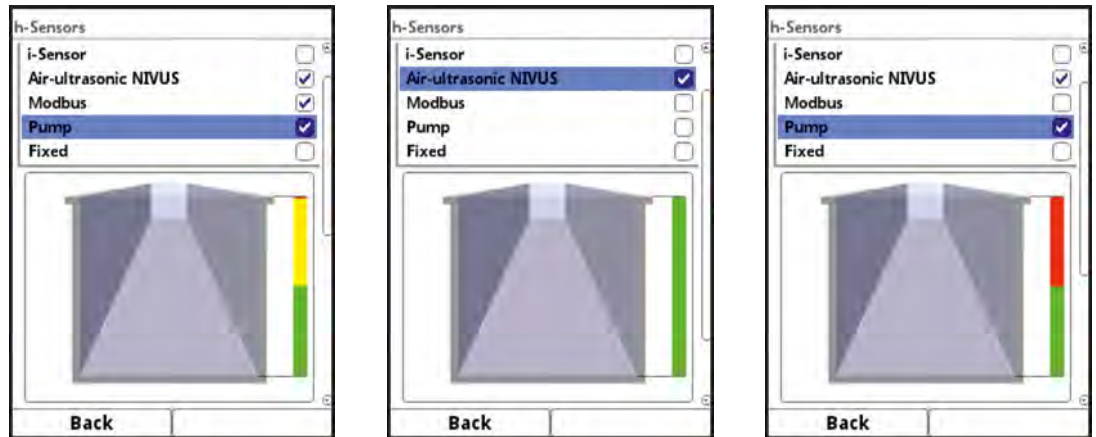

Fig. 23-8 Selection of sensors and representation of measurement ranges

One to three coloured programming sections are indicated below the channel graph depending on type and number of the selected sensors. The colour of these programming sections corresponds with the colour of the vertical bar as well as the assigned sensors.

- Measurement range
 - Top: red
 - Centre: yellow
 - Bottom: green
- Number of sensors used
 - One sensor: solid green bar
 - Two: combination green/red

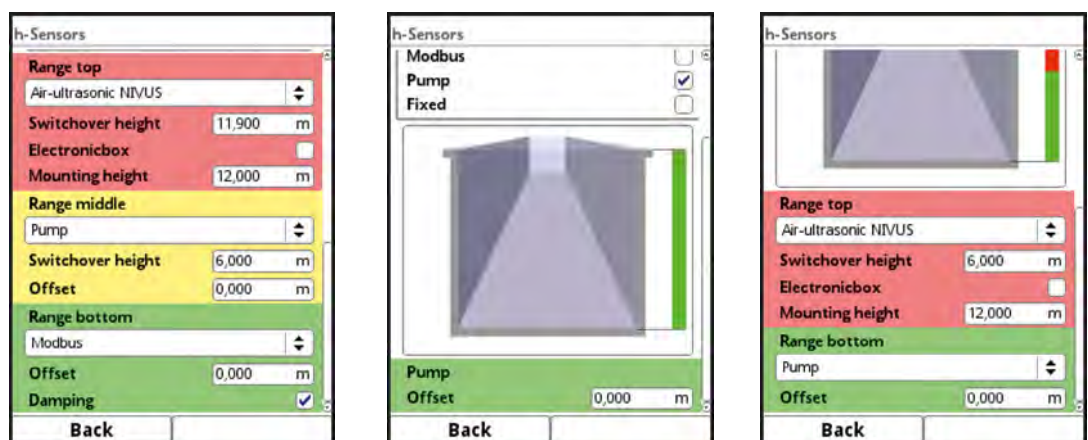

Fig. 23-9 Representation of programming sections

A level sensor can be assigned to each one of the programming sections (see Fig. 23-7). The transmitter will assign the sensors to the appropriate programming section automatically. The assignment depends on the channel shape set before.

- Air-ultrasonic: top measurement range

- Pump: bottom measurement range
- and others

This assignment can be modified as desired. The assignment menu will show only the sensors which have been selected previously (Fig. 23-7).

It is also possible to use one level sensor for two or three programming sections. In such a case the other level measurement values activated will be saved only in the internal memory and will not be used for calculation purposes.

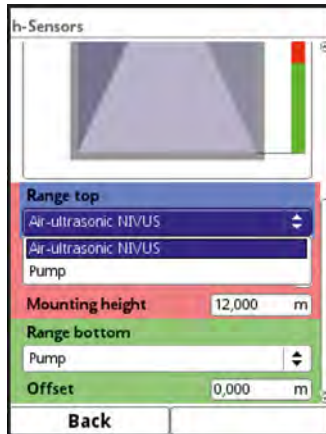

Fig. 23-10 Assigning level sensors to programming sections

The range of each programming section can be modified. This modification is done by adjusting the according >Switchover Level<.



Important Note

Observe to accurately specify the positioning values of the individual sensors.

Furthermore an offset can be specified to adjust the frequency converter.

Enter the values by using the virtual keypad (see chapter „19.3 Use/Entry using the letter block“).



Fig. 23-11 Offset

The sensor types POA and CS2 vary in terms of sensor height depending on their construction. The differences are detected by the system automatically when connecting the sensors and will be taken into account accordingly.



Important Note

When using i-Sensors (connection via HART interface) necessarily observe to specify the correct sensor type. The transmitter automatically accepts the sensor-specific data.

In the i-Sensors menu tick iXT/MPX as soon as the i-Sensor is connected using the HART interface of an iXT.

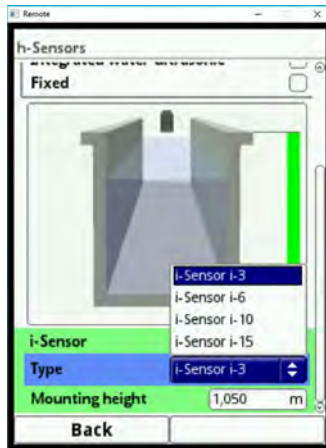

Fig. 23-12 Programming i-Sensor



Hints on i-sensor

The i-sensor **Zone 1** is encapsulated and is connected **only directly** to the NivuFlow.

The i-sensor **Zone 0** is intrinsically safe and shall be connected **only** to the iXT Ex separation module.



Note

i-Series sensors have pre-programmed measurement ranges. For further reference please see the i-Series sensors instruction manual.

i-Sensors can be put into operation even without using a HART modem. To do so enter the sensor's measurement span in the parameter "Measurement span". Depending on the sensor installation height it may be necessary to additionally set a negative offset value.

| | i-3 | i-6 | i-10 | i-15 |
|--|-------|-------|-------|-------|
| Distance to sensor face in [m] at 4 mA (empty) 0 % | 3,0 | 6,0 | 10,0 | 15,0 |
| Distance to sensor face in [m] at 20 mA (full) 100 % | 0,125 | 0,300 | 0,300 | 0,500 |
| Max. possible measurement span in [m] | 2,875 | 5,7 | 9,7 | 14,5 |

Tab. 23-13 Measurement span of i-Sensors



Important Note

If the i-Sensor is connected via a type iXT Ex Separation Module or a Multiplexer MPX it is necessary to enable the use of iXT/MPX in >Main Menu</>Connections< prior to setting the sensor type.

Without this activation the connection cannot be selected in the >h-Sensors< menu.

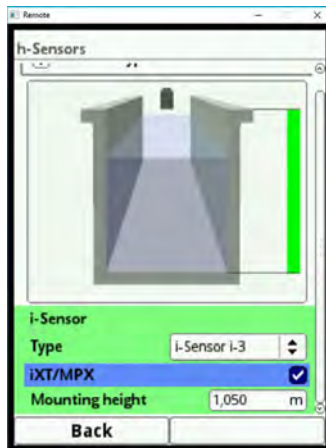

Fig. 23-14 Activation HART interface in iXT/MPX

The specification of the mounting height of the i-Sensor relates to the distance between the bottom sensor edge and the channel zero point. This value defines the zero point of the measurement. It is essential to set this value carefully and as accurate as possible since this setting will influence the measurement using i-Sensors immediately.

23.3 Setting Parameters in v-Sensors Menu

The third important point besides the measurement place and the level sensors is the setting of the flow velocity sensor parameters. This menu comprises among the sensor type and the number of sensors even the spatial position. Specifications within this menu relate to the shape as well as the dimensions of the defined channel shape (see chapter „23.1.2 Channel Profiles“).

23.3.1 Number of Flow Velocity Sensors

It is possible to connect up to three flow velocity sensors to the NivuFlow Energy Saver transmitter (two or three via iXT/MPX).



Fig. 23-15 Selection menu flow velocity sensors

➡ Procedure to select additional sensors:

1. Open the >v-Sensors< menu.
A selection field showing the figures 1-x can be found in the top right area of the display. This selection field can be used to set the parameters for all connected flow velocity sensors successively.
Default setting: v-Sensor 1 active as first sensor.
2. Press the right function key (Tab) to go to v-sensor 2.

3. Tick the >Active< option. The parameters for the active sensor can now be set. The active sensor is shown directly in the application graph. The sensor you are about to program is indicated in colour. At the same time, the remaining sensors available are indicated as outlines.

23.3.2 Sensor Types

Five different sensor types can be selected in total:

- Wedge (POA and CS2 sensors)
- Pipe (POA and CS2 sensors)
- Float (not supported in this firmware version)
- EBM without pressure (connection of CSM-V100 wedge sensor via EBM electronic box)
- EBM with pressure (connection of CSM-V1D0 wedge sensor via EBM electronic box)

The selected sensor shape >Wedge< or >Pipe< is shown in the correlation measurement graph.

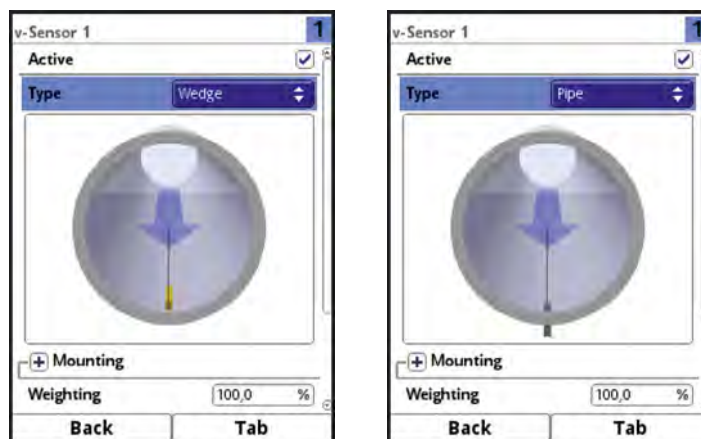

Fig. 23-16 Representation wedge or pipe sensor

23.3.3 Mounting position of v-Sensors

There are additional application parameters which can be specified for the mounting of the v-sensors. These parameters are mainly intended for mounting positions other than the default settings.

➡ Procedure:

1. Turn the rotary-pushbutton until the >Mounting< field is highlighted blue.
2. Press the rotary-pushbutton - the PLUS on the left turns to MINUS and an input menu opens.

Selection flush with the wall (available only with pipe profiles)

This selection is used to specify the three interdependent parameters >Mounting Height<, >Distance Centre< and >Mounting Angle<.

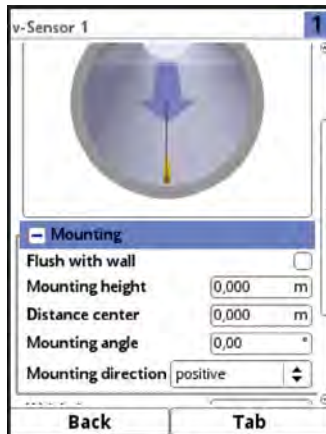

Fig. 23-17 Programming using height, distance and angle

Alternatively it is sufficient to enter only the beam angle if the sensors are to be installed flush with the wall. The entry is required if:

- wedge sensors are fastened directly on the wall of the slanted surface or
- pipe sensors are inserted from the outside at a right angle.

The use of the **1-Parameter-Programming by using the mounting angle only** assumes a beam angle pointing to the centre/segment of a circle and requires the sensors to be installed as described above. This option significantly facilitates correct programming.

➡ Procedure:

1. Tick >Flush with Wall< in the selection field.
The input fields below will hide. Only the >Mounting Angle< input field is active.
2. Enter the sensor mounting angle.
3. Verify your entry.
The graph represents the sensor in the specified mounting angle.

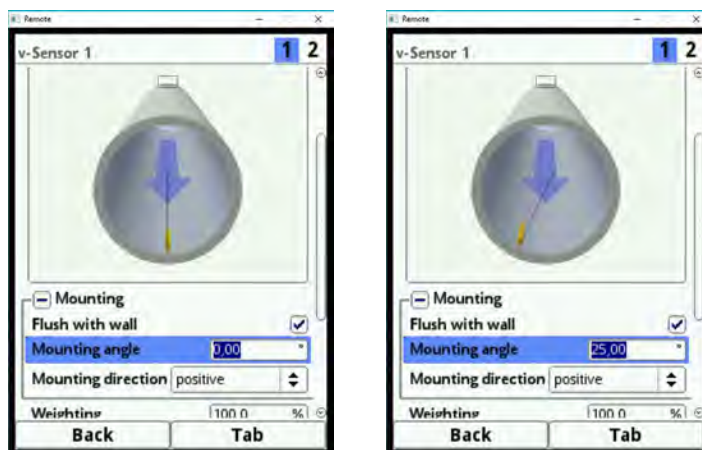

Fig. 23-18 Setting the Mounting Angle Parameter

Mounting Height

➡ Procedure:

1. Measure the distance between the bottom edge of the base plate (v-sensor) and the lowest point of the channel bottom.
2. Turn the rotary-pushbutton until >Mounting Height< is active.
3. Enter the measured distance here.
Default setting: unit METER.

If the sensor is screwed to the lowest point on the bottom (or has been inserted from the outside as pipe sensor at the lowest point of the application) it is not necessary to specify a value.

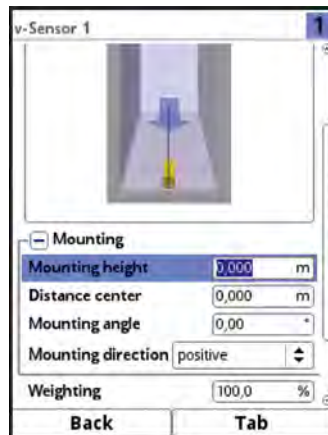

Fig. 23-19 Setting the Mounting Height

If a sensor needs to be installed on a **block** due to the **risk of soiling** or **sedimentation** this distance shall be taken into account.

➔ Procedure:

1. Determine the sensor positions related to the zero point of the application. The bottom edge of the base plate is the reference point, for pipe sensors the horizontal surface of the sensor face.
2. Enter this distance in the >Mounting Height< field.

Input Field Distance Centre



Hints on the direction of view

Users look opposite the direction of flow, the v-sensors in the opposite direction (away from the user).

The sensor parameters are set as follows:

- v-Sensor 1 is always in the centre of the application

The transmitter's calculation is based always on the installation of the v-sensor in the centre. As soon as the v-sensor is installed out of the centre the offset shall be specified in the >Distance Centre< field.

- Negative values move the sensor to the left
- Positive values move the sensor to the right

When using two v-sensors the sensor positions need to be entered in the >Distance Centre< field. The value relates to the measurement place centre.



Fig. 23-20 Entering sensor positions related to application centre

Input Field Angle

Default setting: v-sensor always measures flow velocities vertically upwards.

Some applications require sensor installation in a slanted position or even horizontal:

- on the side of channel walls
- in the round section of pipes

In such a case the altered beam angle must be specified in the transmitter. The reference point here is the vertical beam of the ultrasonic signal pointing upwards.

The following applies for the setting of the **slant of the beam angle**:

- negative value - tilt to the left
- positive value - tilt to the right
- 90° - horizontal beam
- 180° - beam downwards (e. g. applications with float)

Installation Direction

This particular parameter is used only for special applications.

Default setting: sensor installation direction always >positive< (measuring against the flow direction).



Note

Do not modify this parameter. Entering >negative< will provide "invalid" flow velocity values.



Fig. 23-21 Sensor installation direction altering options

23.3.4 Weighting

In case of using two flow velocity sensors the weighting of each individual flow sensor for the measurement result of the average overall velocity must be defined. The weighting is specified as % in the >Weighting< field.

Default setting: 100 %.



Note

The weighting value depends on the application and the sensor position.

Such applications require comprehensive expert knowledge on fluid dynamics and should be conducted by NIVUS commissioning personnel or an authorised expert company.



Fig. 23-22 Weighting of v-Sensors

23.3.5 Limiting the Velocity Evaluation

The >v-Minimum< and >v-Maximum< input fields are relevant for the limiting of the flow velocity evaluation. Here the maximum permissible negative as well as positive velocities can be specified.

A typical application is to avoid the evaluation of negative flow velocities (backflow). In such a case simply set the maximum permissible flow velocity to "0".



Note

It is not possible to increase the possible flow velocity evaluation to values higher than the technical limits as specified in chapter „10 Specifications“. Such entries will be blocked and rejected.

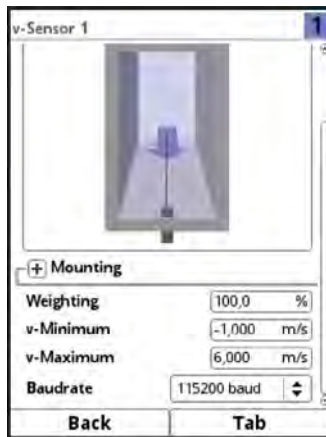

Fig. 23-23 Limiting the velocity evaluation

23.3.6 Data Transmission Rate

Baud Rate

The baud rate denotes the number of transmitted symbols per time unit and hence describes the transmission speed.

Default setting: 115 200 baud.

NIVUS recommends to maintain this setting. Only in very rare cases if problems between transmitter and sensor should occur (e. g. if a very long cable is used) it may be helpful to reduce the baud rate.



Fig. 23-24 Baud Rate

23.4 Inputs and Outputs (analog and digital)

This menu is to define the functions of the analog as well as digital inputs and outputs. Further parameters such as measurement ranges and output spans, offsets, limit values, error responses etc. can be set here too.

Open the >Inputs/Outputs< menu from the main menu.



Fig. 23-25 Selection of inputs and outputs

The Inputs/Outputs menu is subdivided into four parts:

- Analog inputs
- Analog outputs
- Digital inputs
- Digital outputs

23.4.1 Analog Inputs

The available analog inputs are shown in the top right corner of the display.

The NivuFlow Energy Saver possesses five analog inputs.

The analog inputs can be selected successively by pressing the right-hand control key >Tab<. The selection is shown as clear text message in the top left corner of the display.

Default setting: analog inputs inactive.

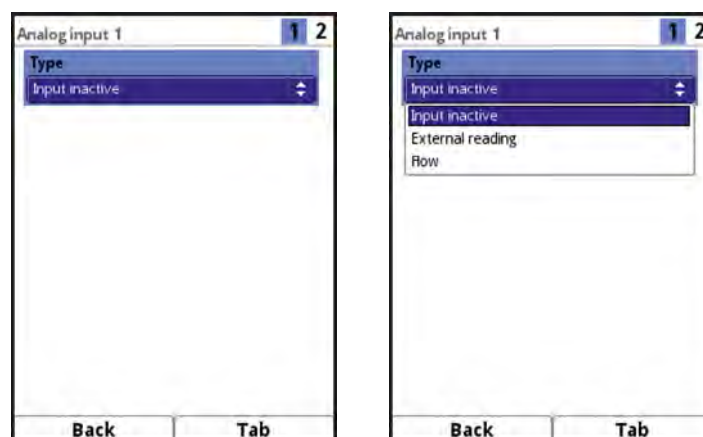

Fig. 23-26 Activation of analog inputs

Currently the analog inputs can be used only for external readings (such as temperature in °C). The transmitter hence can be utilised as an extra data logger for readings from other systems. This, however, does not affect the transmitter's functionality as flow meter.

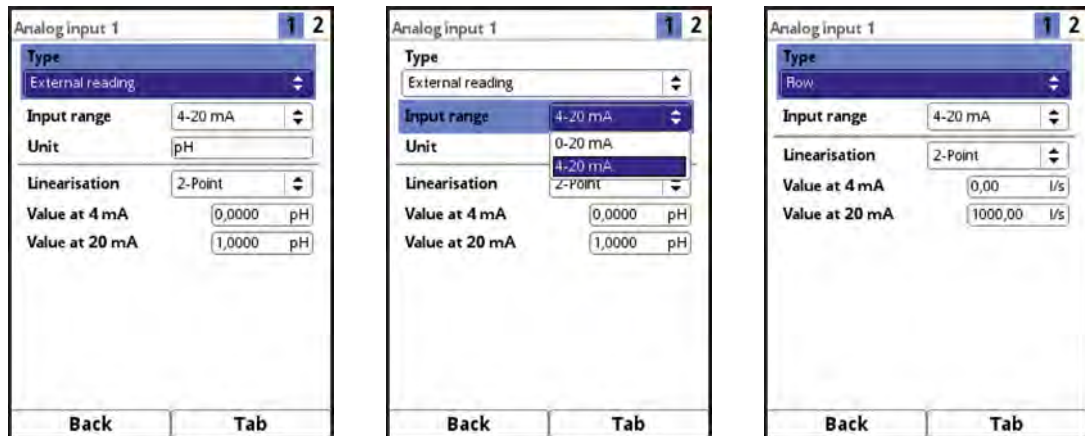

Fig. 23-27 Analog input parameters

After activating the analog inputs the input ranges can be set to either >0-20 mA< or >4-20 mA<.

The units selection field can be used as text input field if "External Measurement Value" has been selected in order to enter individual units optionally. The number of characters for the individual input of units is limited to five digits.

For "Flow" the unit (according to the units selected with the language settings) is fixed and cannot be modified.



Note

Keypad input: see chapter „19 Operation Basics“.

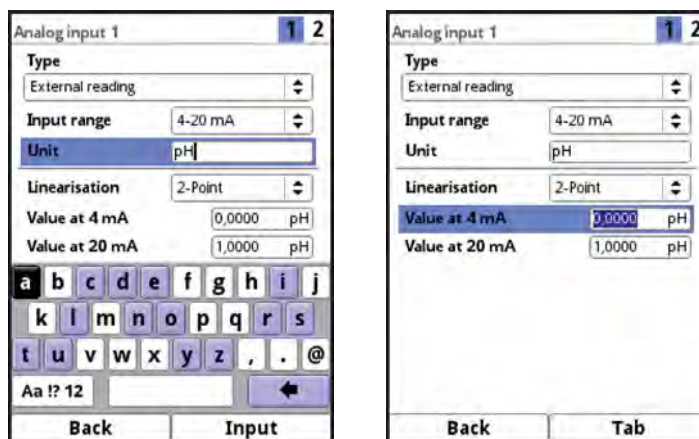

Fig. 23-28 Determination of units and scaling of storage

Then set the parameters for the scaling of the storage.

23.4.2 Analog Outputs

The available analog outputs are shown in the top right corner of the display. The NivuFlow Energy Saver possesses four analog outputs.

The analog outputs can be selected successively by pressing the right-hand control key >Tab<. The selection is shown as clear text message in the top left corner of the display.

Default setting: Analog outputs inactive.

The analog outputs can be assigned to varying functions. It is possible to assign the same function in different measurement ranges to two analog outputs.

- Example:
 - Analog output 1 = flow 4-20 mA is equal to 0-100l/s
 - Analog output 2 = flow 4-20 mA is equal to 0-5000l/s

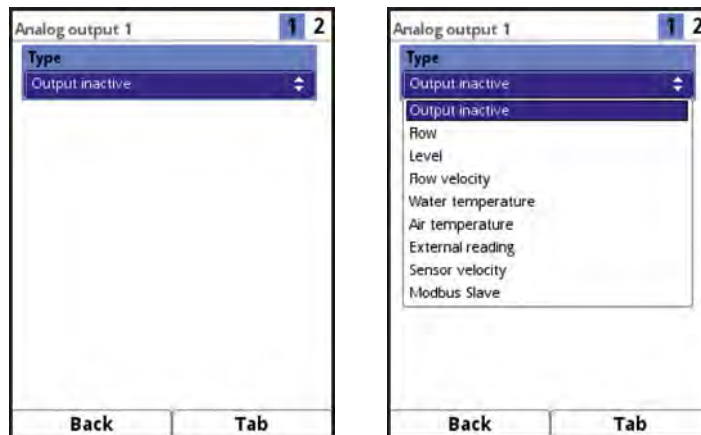

Fig. 23-29 Activation of analog outputs

The functions below can be assigned to an analog output:

- **Flow**
The application flow rate (calculated from average flow velocity and wetted cross section) is available on the selected analog output.
- **Level**
The level used for calculation is available on the selected analog output. This is the level value active in menu >Application</>h-Sensors< for the current level area.
- **Flow velocity**
The calculated average flow velocity (possibly calculated even from two or three sensors) used to calculate the current flow rate is available on the selected analog output.
- **Water temperature**
The medium temperature detected by POA or CS2 flow velocity sensors is available on the selected analog output.
- **Air temperature**
This is where the measured air temperature is available as soon as an air-ultrasonic sensor OCL-L1 is used for the application. The sensor utilises the air temperature to compensate sonic runtime errors.
- **External measurement value**
Readings fed to the analog input (and possibly linearised) are available here.
- **Sensor velocity**
If multiple flow velocity sensors are in use and the average flow velocity of the individual measurement paths is to be determined it is possible to select the desired flow velocity sensor and to issue its readings on the analog output.

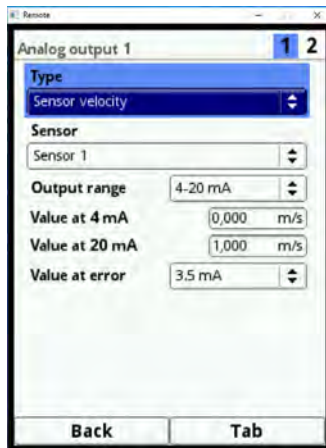

Fig. 23-30 Selecting the sensor velocity

- **Modbus Slave**
Using Modbus the analog output can be used for controlled output of signals from other systems.

The **output range** can be set after the function has been chosen:

- 0-20 mA
- 4-20 mA

Then adjust the **output span**.

A certain **error behaviour** can be set for the analog output in case of error. The adjustments below can be set in case of error:

- 0 mA
- Hold value (holds the latest valid reading (Hold))
- 3,5 mA
- 21 mA

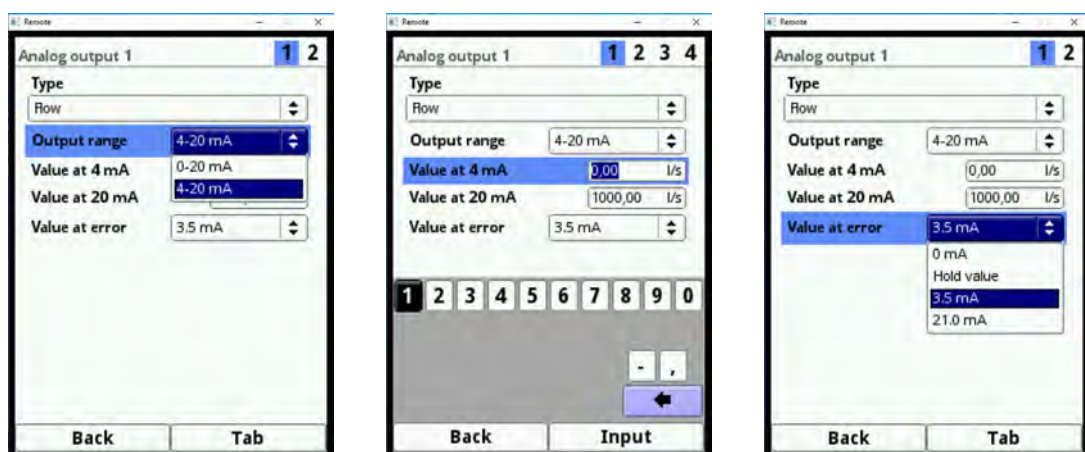

Fig. 23-31 Output range/output span/error response

23.4.3 Digital Inputs

The available digital inputs are shown in the top right corner of the display.

The NivuFlow Energy Saver possesses seven digital inputs.

The digital inputs can be selected successively by pressing the right-hand control key >Tab<. The selection is shown as clear text message in the top left corner of the display.

Default setting: digital inputs inactive.

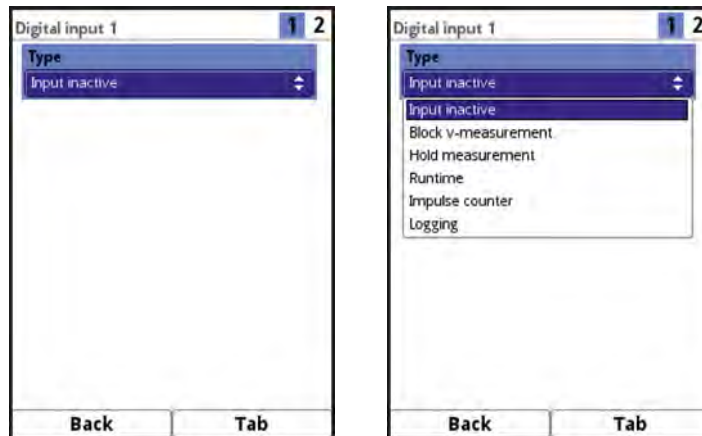

Fig. 23-32 Activation of digital inputs

The following functions can be assigned to the digital inputs:

- **Block V-measurement**

The flow measurement can be blocked as long as there is a signal available on the digital input by using an external contact (float switch, pressure bell switch...). This is useful for applications such as very full overflow channels without actual discharge featuring movement caused by wind, waves, ship traffic or similar.

The measurement here is released using a contact maker installed in the separating structure. The contact maker shall be positioned immediately before the overflow start.

If this function is selected the logic can be additionally adjusted as follows:

- Non-inverting digital input
- Inverting digital input

- **Hold measurement**

Measurement or readings are retained and will be processed unchanged while the measurement place or the application is modified. This permits to carry out required tasks without generating error messages in a process control system.

If this function is selected the logic can be additionally adjusted as follows:

- Non-inverting digital input
- Inverting digital input

- **Runtime**

The system detects and saves the duration of the oncoming signals on the digital input. Such records are used e. g. for the runtimes of pumps or other units.

If this function is selected the logic can be additionally adjusted as follows:

- Non-inverting digital input
- Inverting digital input

- **Impulse Counter**

The system counts and saves the number of oncoming signals on the digital input. The impulses are counted by detecting the status change of the digital input (1->0 or 0->1).

If this function is selected it is possible to determine which edge to evaluate:

- Rising edge (status change "0" to "1")
- Falling edge (status change "1" to "0")

- **Recording**

An oncoming signal is recorded including start and stop (time stamp function) and is then saved.

Areas of use:

- Access control
- Recording of events
- Runtimes
- and others

If this function is selected the logic can be additionally adjusted as follows:

- Non-inverting digital input
- Inverting digital input

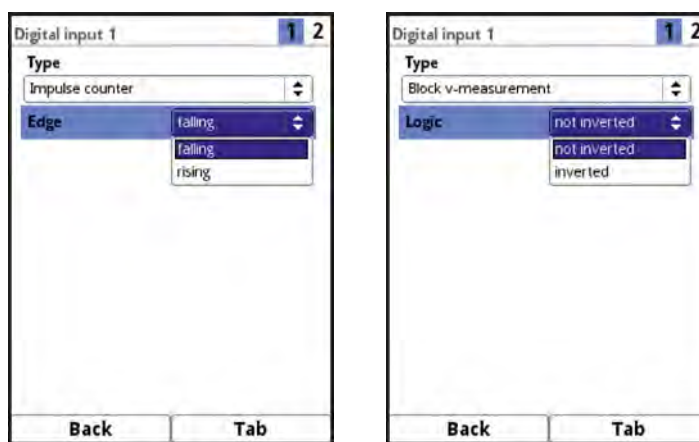

Fig. 23-33 Logic/edge options

23.4.4 Digital Outputs

The available digital outputs are shown in the top right corner of the display.

The NivuFlow Energy Saver possesses five digital outputs.

The digital outputs can be selected successively by pressing the right-hand control key >Tab<. The selection is shown as clear text message in the top left corner of the display.

Default setting: digital outputs inactive.

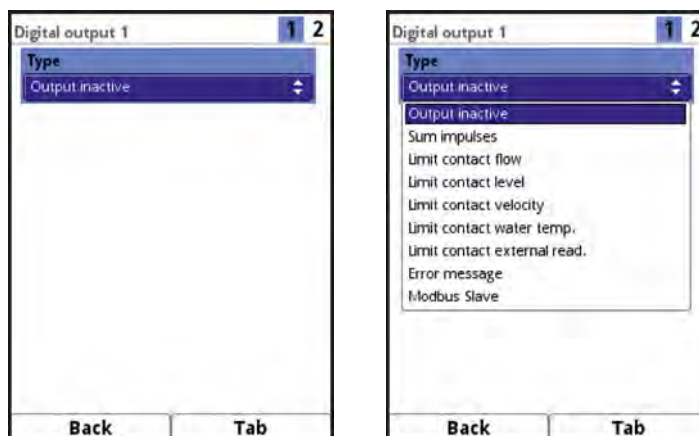

Fig. 23-34 Activation of digital outputs

The following functions can be assigned to the digital outputs:

- **Sum impulses**

Output of volume-proportional sum impulses.

The parameters below can be set:

- Value (impulse per volume)
- Output logic (n.c./n.o.)
- Impulse duration (relay energised/de-energised); duration: 100...5000 ms

If the impulse frequency of the impulse output is lower than the frequency of the flow rate in case of strongly rising flow rates the sum impulses not yet issued will be saved internally until the calculated flow rate falls below the impulse frequency again. After that the sum impulses will be issued.

$$\text{Max. impulse frequency [Hz]} = \frac{1}{2 \times \text{Impulse duration}}$$

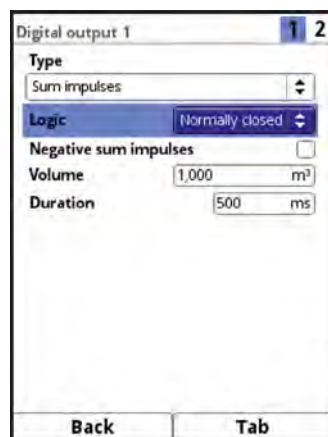

Fig. 23-35 Programming the impulse generator

- **Limit Contact Flow**

Set one flow limit value for >Threshold On< and >Threshold Off< each. Exceeding this flow limit value will issue a digital signal. This digital signal will be reset as soon as the value falls below the second flow limit value = hysteresis function to avoid output flutter.

After selecting this function the logic can be adjusted as follows:

- Normally closed
- Normally open

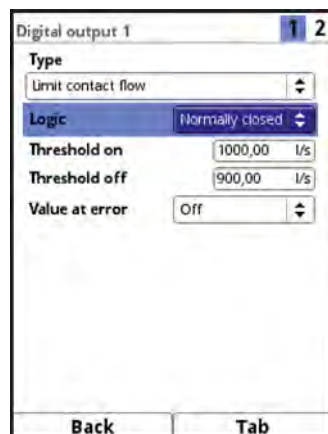

Fig. 23-36 Programming the limit contact

- **Limit Contact Level**

The procedure to use the level limit contact is the same as for the flow limit contact.

Set a level limit value.

The level enabled in >Application</>h-Sensors< for the current level range is used for calculation. It is not possible to use a free selectable level sensor.

After selecting this function the logic can be adjusted as follows:

- Normally closed
- Normally open

- **Limit Contact Velocity**

Here the digital signal in the event of overshooting an adjustable velocity limit value will be issued.

Proceed as described under >Limit Contact Flow<.

The calculated average flow velocity (calculated even from 2 or 3 sensors) is used.

After selecting this function the logic can be adjusted as follows:

- Normally closed
- Normally open

- **Limit Contact Water Temperature**

Here the digital signal in the event of overshooting an adjustable temperature limit value will be issued.

After selecting this function the logic can be adjusted as follows:

- Normally closed
- Normally open

- **Limit Contact External Value**

Here the digital signal in the event of overshooting an adjustable limit value will be issued.

The limit value properties are defined in the analog input section.

After selecting this function the logic can be adjusted as follows:

- Normally closed
- Normally open

- **Error message**

The individual error types to issue can be assigned to the digital output by ticking the according check boxes using the rotary-pushbutton.

Furthermore it is possible to toggle the output logic between normally open and normally closed.



Note

Digital output 2 is not suitable as error output since it is designed as a bi-stable relay. Once de-energised the relay will retain its latest position and hence cannot be used for error messages.



Fig. 23-37 Error mask

- Modbus Slave**
 The digital output can be used via the Modbus for the controlled output of signals from other systems.



Fig. 23-38 Logic options

23.5 Pump / Frequency converter

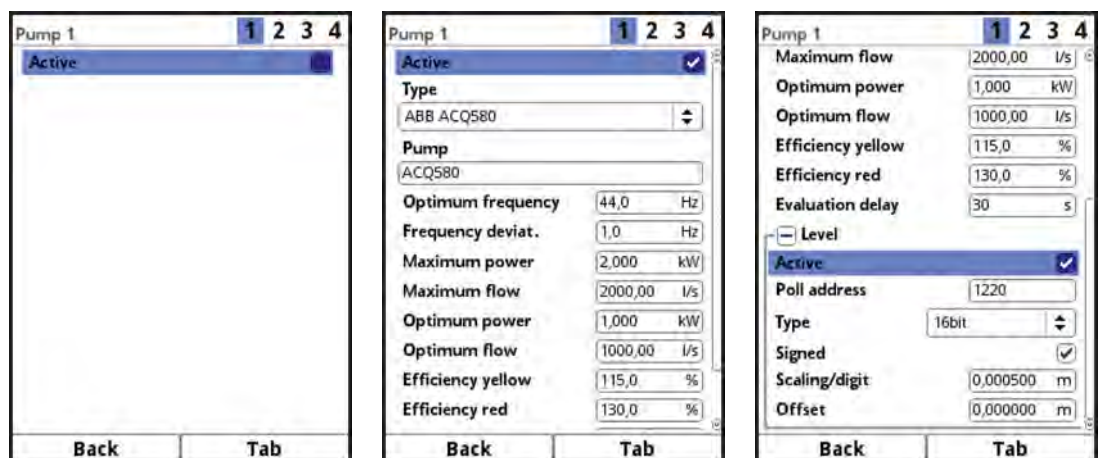

Fig. 23-39 Pump

Pumps 1...4 are indicated top left, the selected pump is highlighted in blue in the top right area. Use Tab to toggle between single pumps.

Per **default** all pumps are deactivated. Ticking the "Active" checkbox will activate the pumps

and extends the screen accordingly

Use **>Type<** to choose the installed pump:

- ABB ACQ580
- ABB ACQ810
- ABB ACS355
- ABB ACS550
- ABB ACS800
- User defined

To use a **user-defined pump** it is necessary to specify supplementary details:

- In the **>Power<**, **>Frequency<** and **>Revolutions/min<** sections select and complete the values below:
 - Poll address
 - Type (16bit, 32bit ABCD, 32bit CDAB, 32bit BADC or 32bit DCBA)
 - Signed
 - Scaling/digit

In **>Pump<** you can specify a name/ID/abbreviation for the according pump.

Enter values under:

- **Optimum frequency**
The optimum pump frequency is determined using the energy consumption/flow rate ratio: reduce the pump frequency of 50 Hz until the efficiency [kWh/MI] reaches the minimum value.
This minimum value is entered in **>Optimum frequency<**.
Operation at optimum frequency permits the best possible energy savings.
- **Frequency deviat.**
Permissible deviation [Hz] from the optimum frequency.
Default setting: -1...+1 Hz
This frequency range (= optimum frequency minus/plus permissible deviation) is used for evaluation according to the traffic lights principle from green (good efficiency) through yellow (medium efficiency) to red (insufficient/poor efficiency).
- **Maximum power**
Maximum power consumption expected
- **Maximum flow**
Maximum flow rate expected
- **Optimum power**
Power consumption [kW] at optimum frequency
- **Optimum flow**
Flow rate at optimum frequency
- **Efficiency yellow**
Deviation [%] from optimum frequency causing the display colour to change from green to yellow

$$\text{Optimum efficiency} = \frac{\text{Optimum power}}{\text{Optimum flow}}$$

- **Efficiency red**
Deviation [%] from optimum frequency causing the display colour to change from yellow to red

- **Evaluation delay**
Specifies the required period the pump needs to be within the frequency deviation before the efficiency is evaluated and the display colour is possibly changing. Temporary limited events (e. g. pump start-up) are consciously not taken into account.

Additionally it is possible to retrieve the pump shaft level from the frequency converter under >Level< (via Modbus).

The function is deactivated per **default**. Ticking the "Active" checkbox activates >Level< and accordingly extends the screen. The following values must be selected/defined:

- Poll address
- Type (16bit, 32bit ABCD, 32bit CDAB, 32bit BADC or 32bit DCBA)
- Signed
- Scaling/digit
- Offset

23.6 Diagnosis

The diagnosis menu is described in chapter „Diagnosis“ starting at page 112.

24 Data Parameter Menu

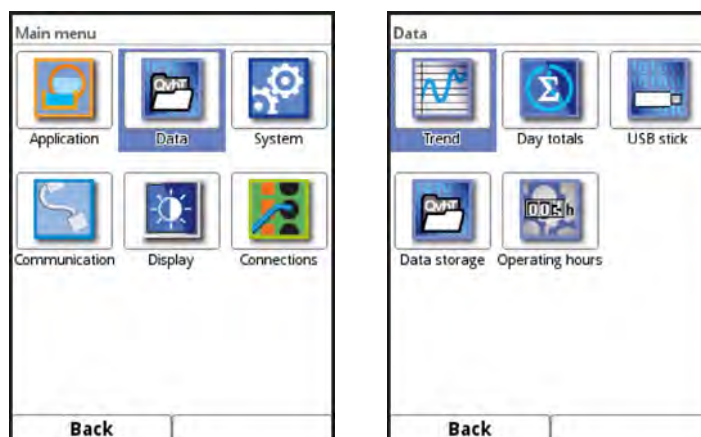

Fig. 24-1 Data menu

24.1 Trend

The trend graph is a representing recorder function. Once you have selected the trend graph you can access previously saved (historic) measurement data.

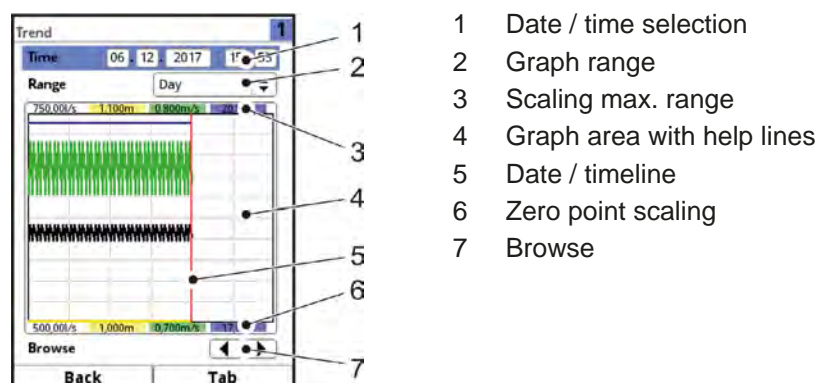

Fig. 24-2 Trend graph screen

➤ Procedure for representation of current measurement data:

1. Select the desired range (period of representation).
The selected range is shown. Measurement data are not automatically updated while represented (the current readings can be found in the lower third of the main screen).
2. In order to get back to the main screen press the left function (Back) three times.

The **Date/Time Selection** (Fig. 24-2 no. 1) can be found in the top area of the main screen. The line is highlighted blue and hence active.

➤ If you wish to select readings covering a certain period (historic data) proceed as follows:

1. Turning the rotary-pushbutton engages the first field (day).
2. Specify the desired day.
3. Turning the rotary-pushbutton again takes you to the next field (month).
4. Repeat you entry until the desired time (day, month, year, hour, minute) is specified completely.
5. Confirm your entry with the right function key. Date and time will be accepted.
The readings are shown in the display depending on the date and the period selected (Fig. 24-2 no. 2).
The vertical red line (Fig. 24-2 no. 5) marks the selected point of time (date and time).

➤ Interrupt your entry by pressing the left function key (back).

Representation:

The selected period covers the area between the left and the right display margin.

The **period** within which data are to be represented can be modified.

➤ Modify the setting using the >Range< section (see Fig. 24-2 no. 2).

1. Turn the rotary-pushbutton until >Range< is highlighted blue.
2. Press the rotary-pushbutton – the selectable periods are shown.

Available are:

- 1 hour
- 4 hours
- 1 day
- 1 week
- 4 weeks

3. Turn the rotary-pushbutton until the desired section is highlighted blue.
4. Confirm your entry with the right function key. The desired period will be accepted.

Representation:

- The vertical red line marks the selected point of time (date and time).
- The representation grid is internally fixed.
- The selected period >Hour< always begins left with minute "0" end ends right with minute "59".
- For increased readability the screen is divided by three vertical help lines. Each division represents a period of 15 minutes.

Underneath the display you can find the **function >Browse<**.

Use the arrow symbols to browse one hour forwards or backwards each time you press the

button.

If **period >4 hours<** is chosen the start of the representation depends on the selected point of time.

Depending on the start time the representation begins:

- 00:00 h
- 04:00 h
- 08:00 h
- 12:00 h
- 16:00 h
- 20:00 h

Representation:

- The range of representation ends exactly 4 hours later on the right side.
- This representation is divided by three vertical help lines too. The distance between the lines is one hour.

Use the >Browse< function to move backwards and forwards within this screen in steps of 4 hours.

If **period >Day<** is chosen the representation begins always on the left at hour 00:00 and ends on the right at hour 24:00.

Representation:

- For increased readability the screen is divided by five vertical help lines. Each division represents a period of 4 hours.

Use the arrow symbols to browse one day forwards or backwards each time you press the button.

If **period >Week<** is chosen the representation begins always on the left at "Monday 00:00 h" and ends on the right at "Sunday 24:00 h".

Representation:

- For increased readability the screen is divided by six vertical help lines. Each division represents one weekday.

Use the arrow symbols to browse one week forwards or backwards each time you press the button.

If **period >4 Weeks<** is chosen the representation begins always on the left at "Monday 00:00 h" and ends on the right at "Sunday 24:00 h".

Representation:

- The reference point in time of the 4-weeks representation is the 29.12.1969, 00:00 h.
- For increased readability the screen is divided by three vertical help lines. Each division represents a period of 7 days.

Use the arrow symbols to browse four weeks forwards or backwards each time you press the button.



Note

Once the period >4 Weeks< is selected it may take a few seconds to load the data completely.

24.2 Day Totals

This is where the flow totals can be viewed in a table. Each value represents a period of 24 hours.

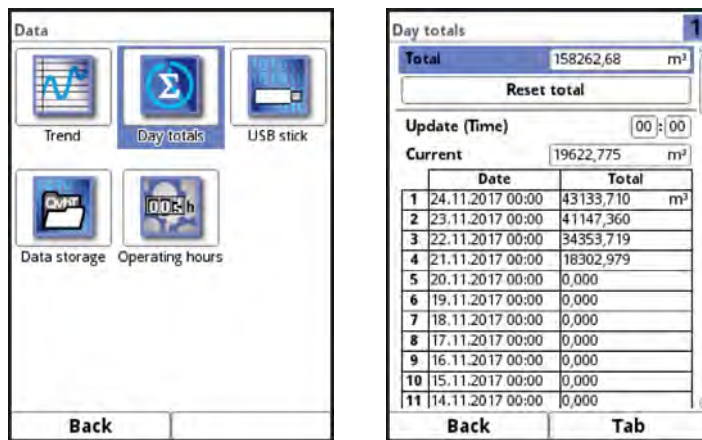

Fig. 24-3 Day Totals

A maximum of 100 totals (= 100 days) is stored. Starting with value 101 always the oldest value will be overwritten (ring memory).

- Turn the rotary-pushbutton to the right to scroll down the table and to the left to scroll up again.

It is possible to view older day totals as well. A prerequisite to view older values is that the unit has run for a longer period.

Example: 98 values – the unit is running for 98 days

In general, only totals created during days with the transmitter actually powered up can be viewed.

If the transmitter should be shut down between two totalising events (< 24 hours) a total will be calculated by using **measured** values. Such a total is **not equal to the real daily flow rate** but corresponds to the rate measured by the transmitter while powered up.

Should the transmitter be shut down before the next totalising event and remains to be shut down until the moment of the following totalising event (> 24 hours) no total will be created for this period (see Fig. 24-4). The according date is specified in the list using the value "0".

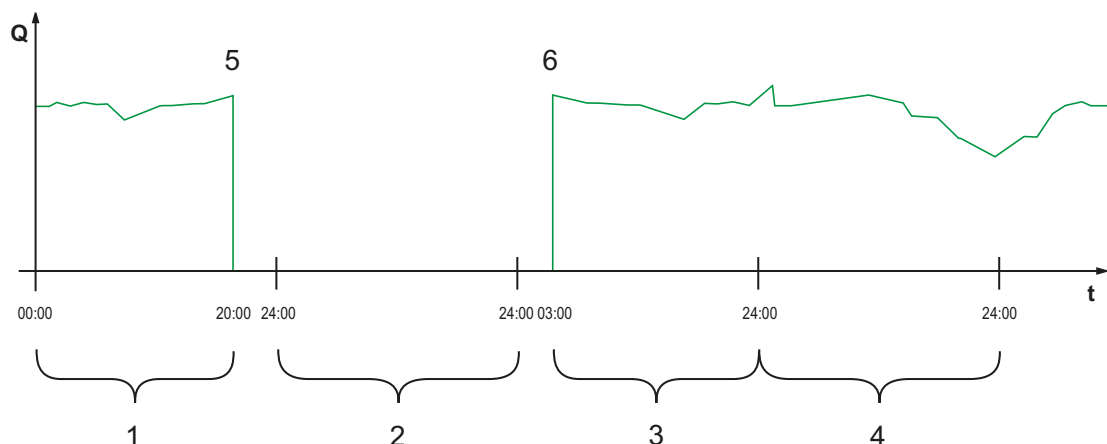

- Total day 1: total covering 20 hours
- Day 2: power failure – total 0
- Total day 3: total covering 21 hours
- Total day 4: total covering 24 hours
- Power failure

6 Power supply restored

Fig. 24-4 Totalising scheme

- The totalising period is set to the period between 00:00 o'clock and 24:00 o'clock as per **default**. This means that the day totals are always created between 00:00 o'clock and 24:00 o'clock.
 - The totals are created at 00:00 o'clock as per **default**.
- ➡ The time of totalising can be modified as follows:
1. Turn the rotary-pushbutton until >Update (Time)< is highlighted blue.
 2. Turn the rotary-pushbutton to activate the hours section.
 3. Specify the desired time to start totalising (e. g. 08:00) and continue turning the button to the minutes section.
 4. Specify the desired minutes.
 5. Confirm your specifications by pressing the right function key >Enter<. The time of totalising has now been changed to 08:00 o'clock.
Due to this settings the 24-h-total will be automatically created covering the period between 08:00 o'clock and 08:00 o'clock of the following day.
Also included are the previous 100 totals which may lead to differences in direct comparison to earlier data backups.

The >Current< field indicates the subtotal accrued since the latest totalising event.

24.3 USB stick**Requirements to USB sticks:**

- USB 2.0 supported
- FAT 32 format (or FAT 12 or FAT 16)
- Maximum permissible memory 32 GB

Working with USB stick:

- ➡ Plug the USB stick into the USB slot located above the display.

Functions:

- Transmission of measurement data to USB stick
- Instrument parameters can be saved to USB stick
- Saved parameter can be restored from USB stick back to the instrument
- Formatting the USB stick



Fig. 24-5 Selection submenu

The transmitter is equipped with an internal data memory. Portions of your measurement data or the complete memory contents can be transmitted to USB stick.

Within this section it is possible to specify the desired period of transmission.

Per default the transmitter is set to transmit the data between the latest transmission and the current point in time. You are free to adjust this period as desired, however.

➤ To transmit data to USB stick proceed as follows:

1. Press the rotary-pushbutton to engage the top field.
2. Turn the rotary-pushbutton to specify the desired start day.
3. Turn the rotary-pushbutton again to get to the month input.
4. Repeat the procedure until the desired date and time have been specified completely.
5. Confirm your entries by pressing the right function key >Enter<.
6. Turn the rotary-pushbutton to highlight the >to< field blue.
7. Turn the rotary-pushbutton to set the desired stop day.
8. Specify the desired stop time as described before. Now the period of data to be transmitted to USB stick is specified.

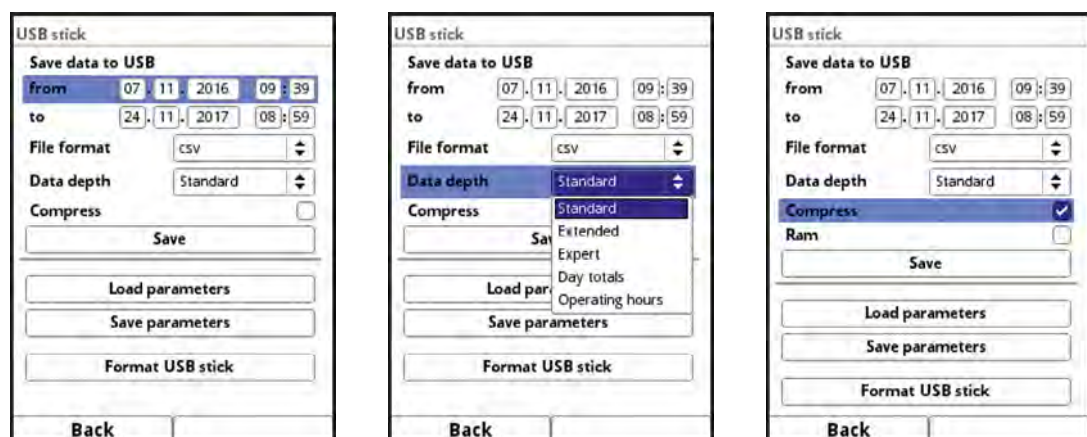

Fig. 24-6 Transmission period/data depth/compression

9. To choose the desired data format turn the rotary-pushbutton which opens a selection menu.

The formats below are available:

- txt
- csv

10. Press the rotary-pushbutton to accept the data format.

The selectable data depth comprises five possible levels:

- **Standard**

This format is sufficient for the most applications.

The data sets saved contain the following information:

- Date and time
- Totaliser
- Flow
- Filling level (pipe)
- Average flow velocity
- Water temperature
- Air temperature (if AUS is used)
- Pump status and pump efficiency of the entire measurement place
- Current (voltage) values as well as the calculated values of the enabled analog inputs
- Digital inputs
- Pump status, power consumption, frequency and efficiency of single pumps
- Frequency converter levels
- Total consumption and total runtime of single pumps

- **Extended**

This data set is useful to check critical relevant applications and is mainly used by service personnel.

The data sets saved contain the following information:

- All data sets from the previous data depth >Standard<
- Average flow velocities from v-sensors 1, 2 and 3 (if used)
- Parameter values for the NIVUS-specific velocity evaluation method >COSP<
- Trigger and hydraulic qualities of v-sensors 1, 2 and 3 (if used)

- **Expert**

Such data sets should be used only by specially trained **service personnel** or the **manufacturer's developers**. These data sets may rapidly become very large. Along with the information found in the extended data sets, the expert set additionally contain all individual gate velocities as well as the gate positions of all connected v-sensors.

Contact NIVUS if required.

- **Day totals**

Export of the latest 100 values

- **Operating hours**

Export of the latest 100 values

The **>Compress< function** makes sense only when large data sets are to be transmitted. In such cases the selected files are zipped as ".zip" files.

➡ After transmission period, data format and data depth have been defined the data can be saved on USB stick.

1. Activate the **>Save<** button.
2. Press the rotary-pushbutton to save the data to USB stick.

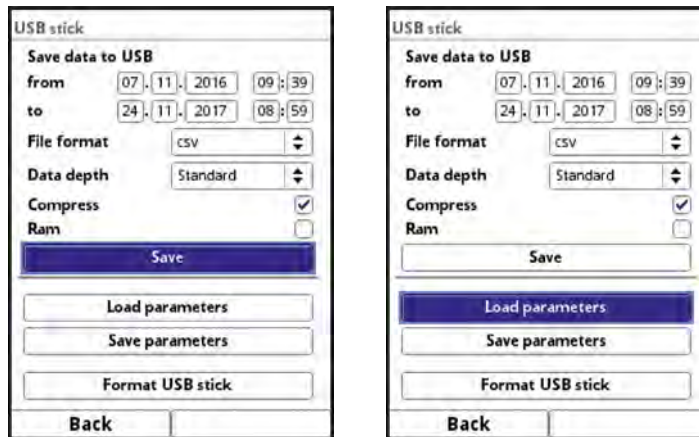

Fig. 24-7 Save/load parameters

The **function >Load Parameters<** permits to load data files previously saved to USB stick back to the transmitter.

By using the **function >Save Parameters<** you can save all parameters of the measurement place to USB stick. During this procedure a total of two files will be created and saved.

Formats of the created files:

- XXXX_DOC_AABBCCDDEE.pdf
This file is for documentation purposes and contains basic settings as well as modified parameter settings.
- XXXX_PAR_AABBCCDDEE.xml
This file contains the complete parameter set of the transmitter and is used to save the parameter settings.

Explanation of file names:

XXXX = Name of measurement place as set
AA = Year
BB = Month
CC = Day
DD = Hour
EE = Minute

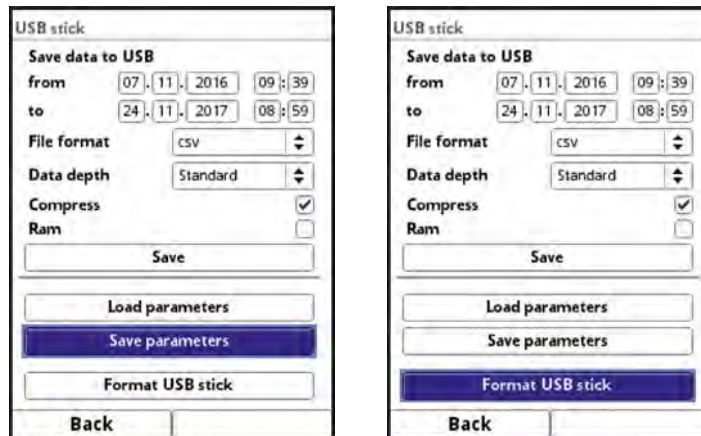

Fig. 24-8 Save parameters/format USB

- ➡ You can convert unformatted or incorrectly formatted USB sticks into the correct format directly on the instrument:
1. Turn the rotary-pushbutton until >Format USB-Stick< is highlighted blue.
 2. Press the rotary-pushbutton to format the plugged USB stick. >SUCCESSFUL< will appear in the display as soon as the stick has been formatted.

24.4 Data Memory (Internal)

This submenu can be used to modify the storage cycle and to erase the internal data memory.

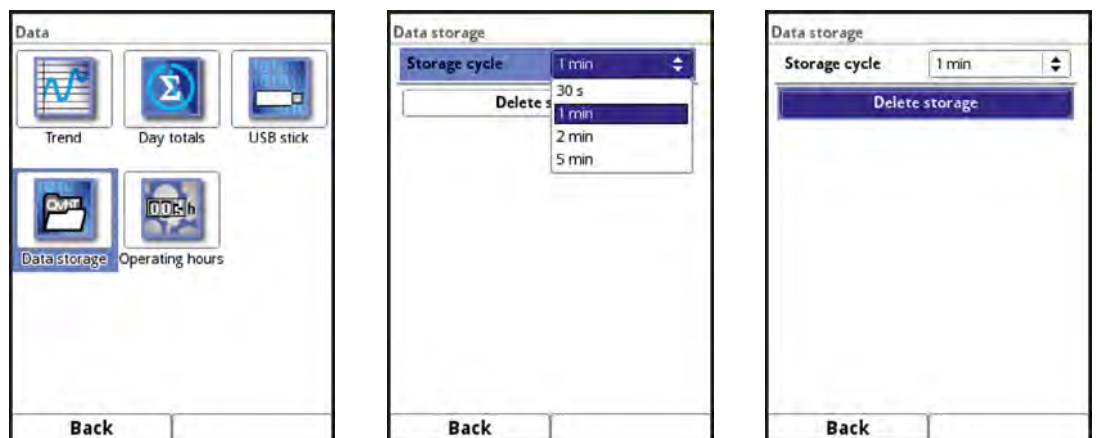

Fig. 24-9 Data memory

Default setting for the storage cycle:

- 30 s
- 1 min
- 2 min
- 5 min

Default setting for the storage cycle: 1 min

Always the mean value covering the entire cycle is saved instead of the instantaneous value at the moment of storage.

You can **erase** the complete internal **data memory**. The memory is password-protected to avoid unintentional deletion.



Important Note

Erased data cannot be restored!

➡ Procedure:

1. Enter the required password to erase data.
2. Confirm the password with the right function key >Enter<.

24.5 Operating hours

The values of the total operating hours as well as the individual day totals can be viewed in the table here. Each value in the table covers 24 hours.

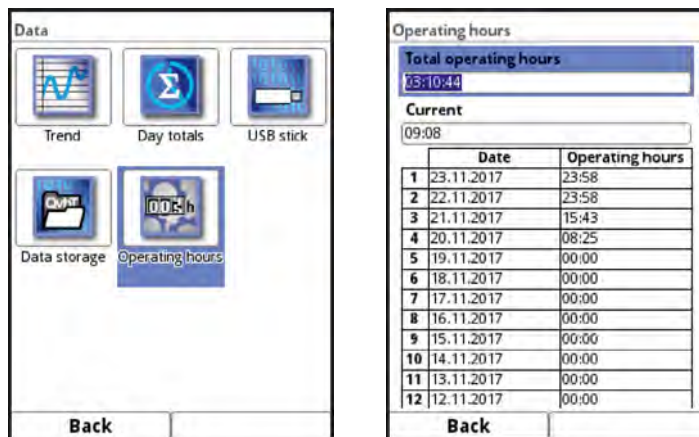

Fig. 24-10 Selecting Operating Hours

A maximum of 100 totals (= 100 days) is stored. Starting with value 101 always the oldest value will be overwritten (ring memory).

➡ Turn the rotary-pushbutton to the right to scroll down the table and to the left to scroll up again.

It is possible to view older day totals as well. A prerequisite to view older values is that the unit has run for a longer period.

Example: 98 values – the unit is running for 98 days

The value "0" is saved as soon as the transmitter has been turned off for longer than 24 hours.

The >Total operating hours< and >Current< values can be selected and specified using the keypad (e. g. if the transmitter had to be replaced).

25 System

25.1 Information



Fig. 25-1 System submenu/system information

This is a read-only menu and contains the instrument information below:

- Serial number and article number
- MAC address
- Firmware version of the transmitter

Furthermore you can find here the following information on the activated sensors:

- Article numbers
- Current firmware versions
- Serial numbers

25.2 Language settings

The following settings can be adjusted in this menu:

- (Operation) Language
- Date format
- Units of measurement values

Here it is possible to distinguish between indicated and saved measurement values.

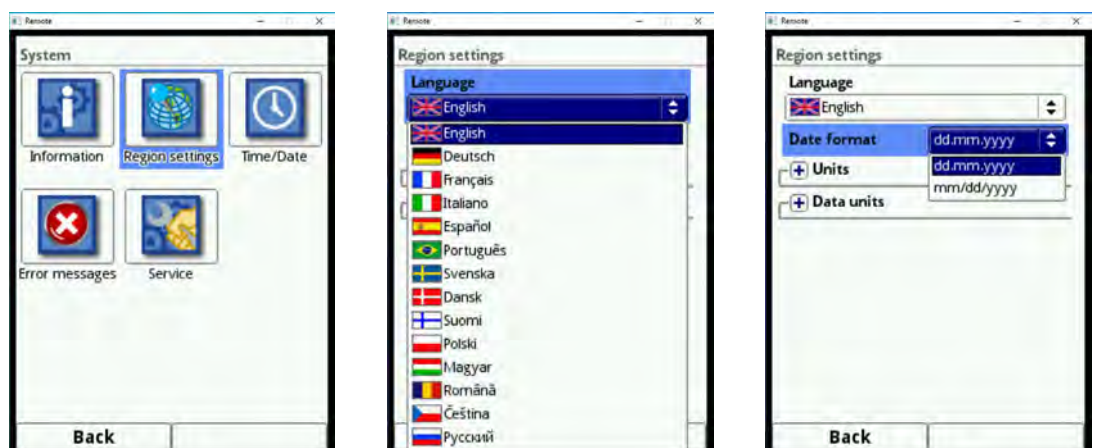

Fig. 25-2 Language settings/language/date format

25.2.1 (Operation) Language

The languages below are currently available:

- English, German, French, Italian, Spanish, Portuguese, Swedish, Danish, Finnish, Polish, Hungarian, Romanian, Czech and Russian

25.2.2 Date Format

The following date formats can be set:

- TT.MM.JJJJ (Day/Month/Year)
- MM/TT/JJJJ (Month/Day/Year)

25.2.3 Units

➡ Procedure:

1. Turn the rotary-pushbutton until the field >Units< is highlighted blue.
2. Press the rotary-pushbutton to turn the PLUS on the left to MINUS and to open the selection list at the same time.
3. Turn the rotary-pushbutton to the desired option.

Decimal Separators

- Comma
- Full stop

The decimal separators specified here are used only for indication in the transmitter display.

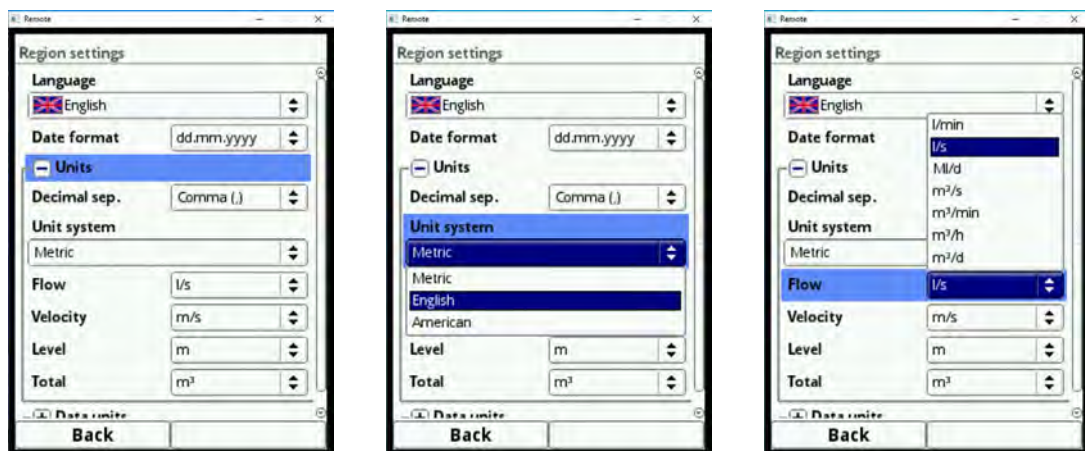

Fig. 25-3 Units system

Units system

Available units:

- Metric
- English
- American

The adjustable units depend on the selected units system:

- In metric system - e. g. liter, cubic metre, cm/s etc.
- In English system – e. g. ft, in, gal/s, etc.
- In American system - e. g. fps, mgd, etc.

Units for display indication

- Flow
- Flow velocity
- Level
- Total

25.2.4 Memory Units

➡ When adjusting the >Memory Units< proceed right as described under >Units<.

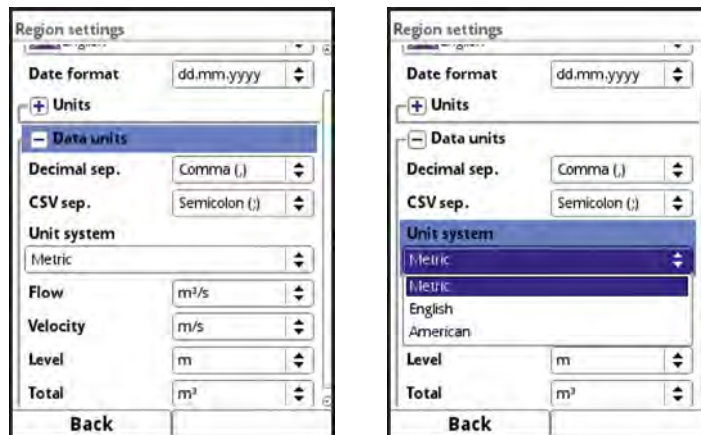

Fig. 25-4 Memory units

In the >Memory Units< section the detected measurement values are **converted and saved** according to the selected unit.

Specifying the decimal and csv separators is vital for the correct read-in of data. When evaluating measurement data using other than German software applications (e. g. English Excel) observe to have the decimal and csv separators selected correctly.

Decimal Separators

- Comma
- Full stop

CSV Separators

- Comma
- Semicolon

Units for storage

- In metric system - e. g. l/s, m³/s, m³/d, cm/s etc.
- In English system - e. g. ft³/s, in, gal/min, Mgal/d, in/s, yd/s etc.
- In American system - e. g. gps, gpm, cfs, cfm, cfh, cfd, mgd etc.

Units for storage of measurement data

- Flow
- Flow velocity
- Level
- Total
- Temperature

25.3 Time/Date

This submenu is used to change the system time of the transmitter and the current date.

This function is required to change over summer and winter time, after power failure or if the internal buffer battery should fail. If the transmitter is operated for a long period the internal clock may deviate. The deviations can be corrected here.



Note

Changing the system time will affect data storage. With the data storage enabled double data sets or data gaps may occur after the system time has been changed.

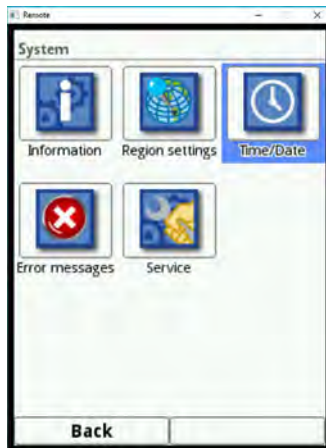

Fig. 25-5 Selecting Time/Date

Here the current system time as well as the time zone (UTC or GMT) relative to the zero meridian can be adjusted.

Furthermore the time server (SNTP) can be activated here.

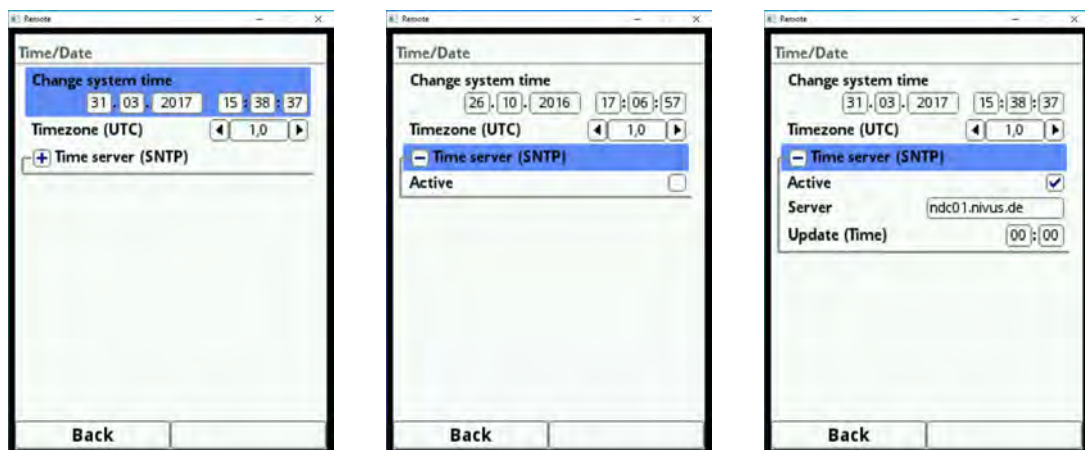

Fig. 25-6 Settings

25.4 Error messages

In this menu it is possible to recall the current oncoming error messages and to delete the error memory.

The memory is password-protected to avoid unintentional deletion.

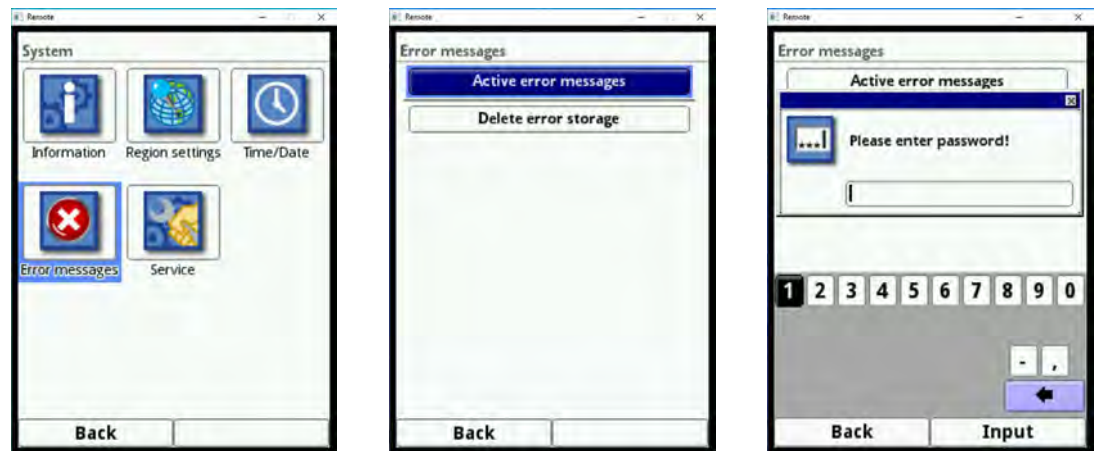

Fig. 25-7 Error messages

25.5 Service

This submenu contains the following functions:

- Service level (unlock)
- Change password (system, not service level)
- Restart (system)
- Restart measurement
- Parameter reset

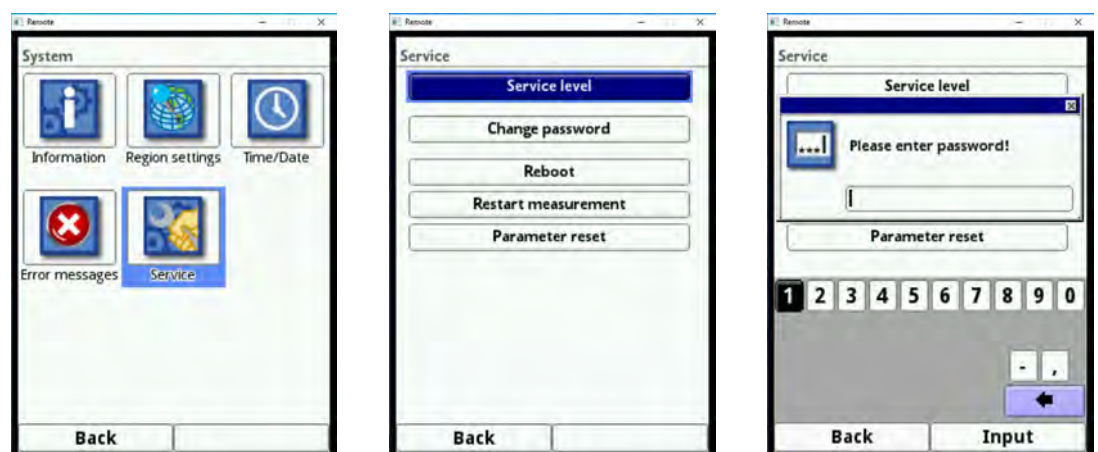

Fig. 25-8 Service

Service Level

The service level is reserved to the NIVUS customer service as well as authorised expert companies and hence is protected by a **special service password**.

System-relevant modifications and special settings for particular applications can be adjusted here.

Such modifications shall be executed by the NIVUS commissioning personnel exclusively!

25.5.1 Change (System) Password

Default password: "2718"

NIVUS recommend to change this password in order to protect the system from unauthorised access. You are free to select any password with a maximum length of ten digits.

For your own safety we recommend to share your password only with **authorised individuals**.

Write down your password and store it in a safe place.

If you should have **lost** your **password** consult the NIVUS hotline. Observe to have the serial number of your NivuFlow transmitter available.

➡ See also chapter „21.2 Change Password“.

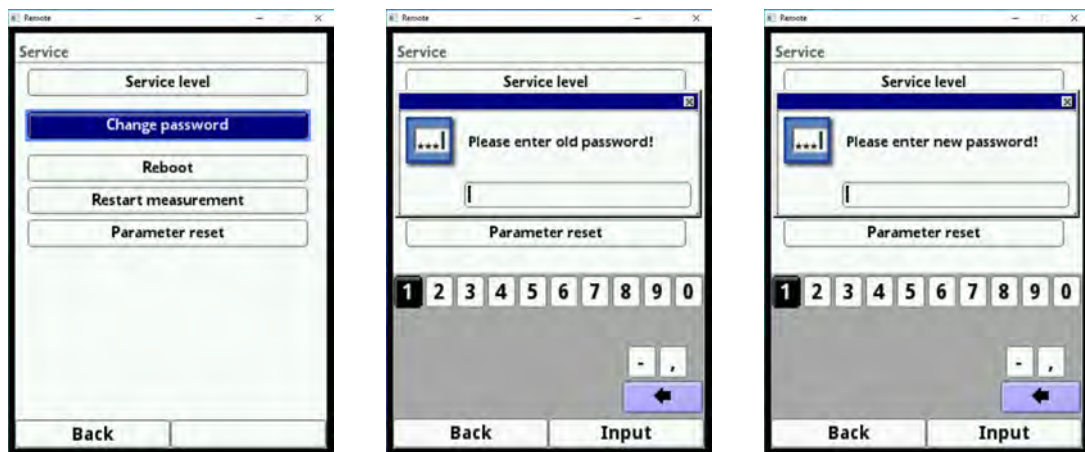

Fig. 25-9 Changing the (system) password

25.5.2 Reboot

A transmitter reboot will interrupt the current measurement process.



Important Note

The system will reboot using the parameters set and saved last.

After booting the system behaves as when the instrument is switched on (analog to PC). This menu point replaces the system shutdown and reboot. All parameters, counters and saved data are retained.



Fig. 25-10 Reboot

25.5.3 Measurement Restart

This option interrupts the currently running measurement process and starts a new measurement.

25.5.4 Parameter Reset

The parameter reset will reset any parameters to default settings. Counters, changed password and saved measurement data are retained.

The actual parameter reset is not executed before you exit the parameter settings menu (back to main menu) and the storage is confirmed. The process can be aborted up to this action.

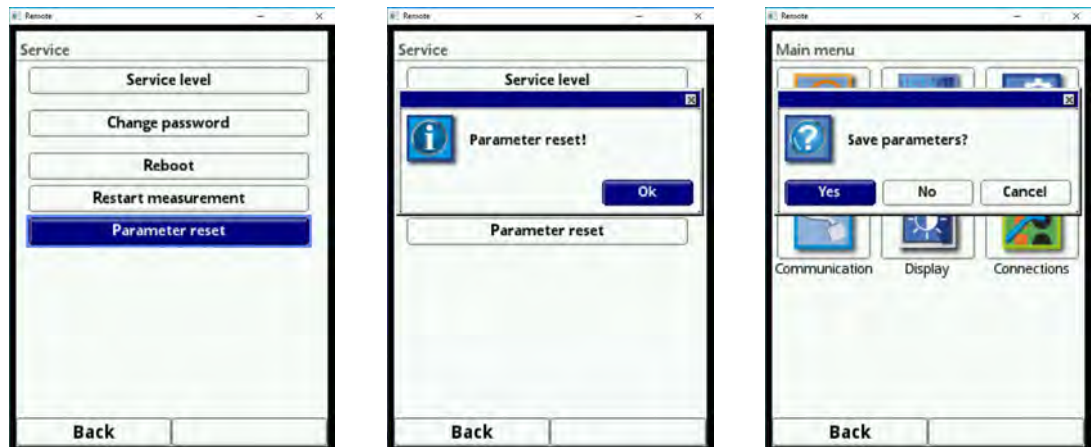

Fig. 25-11 Resetting the parameters to default settings

26 Communication Parameters Menu

This menu is used to set up communication to other devices.

Furthermore the network integration can be set up here as well. The details will not be explained here.

If you should not have the required IT skills we recommend to leave such tasks to **IT specialists** or the **NIVUS commissioning personnel**.

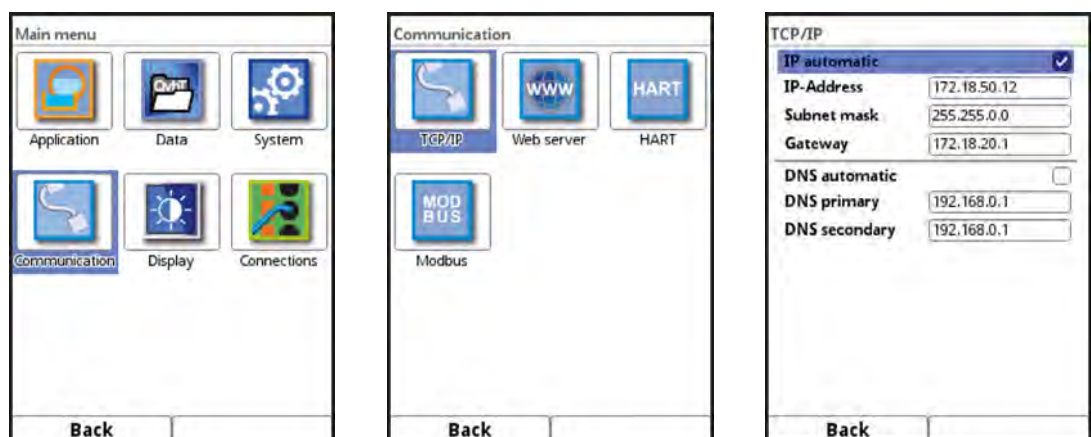

Fig. 26-1 Communication

TCP/IP

Settings for data transport within a decentralised network.

Webserver

Settings for SSL, HTTP and FTP and activation of NF Remote and Telnet.



Fig. 26-2 Web Server

HART

The transmitter can currently not be used as HART slave for following systems (in preparation).

Modbus

It is possible to integrate the transmitter into other systems via Modbus.

The Modbus protocols available upon request if required. Contact the NIVUS GmbH headquarters in Eppingen.

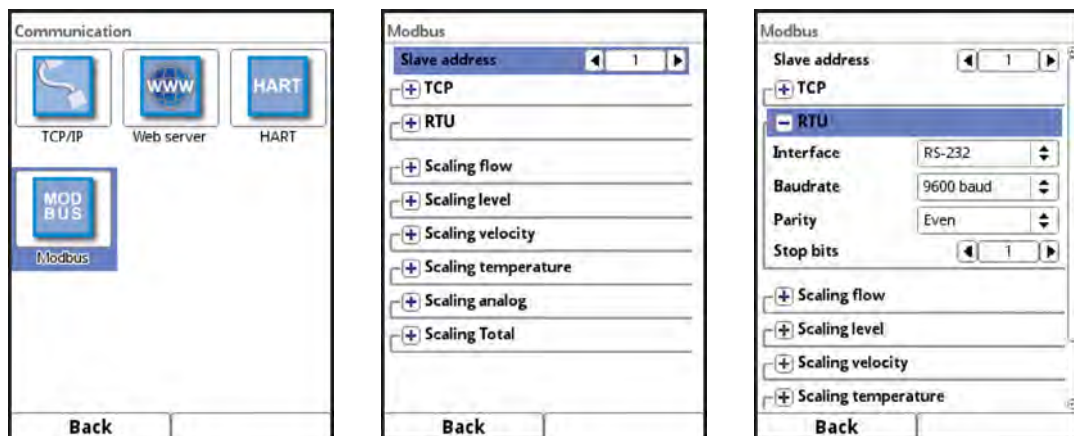

Fig. 26-3 Modbus

The functions below are available here:

- Slave address (1 to 247)
- TCP (Port)
- RTU
 - Interface (RS232 or RS485)
 - Baud rate (1200, 2400, 4800, 9600, 19200, 38400, 57600 or 115200 baud)
 - Parity (None, Odd or Even)
 - Stop bits (1 or 2)

Moreover scalings to transfer measurement values (flow, level, velocity, temperature, analog and total) can be set (Fig. 26-3).

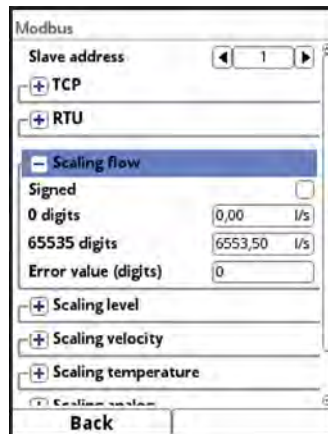

Fig. 26-4 Programming measurement value scaling

27 Display Parameters Menu

In the display menu the following settings can be adjusted:

- Backlight
- Designation of the five main screen fields
- Decimal places of individual value representations

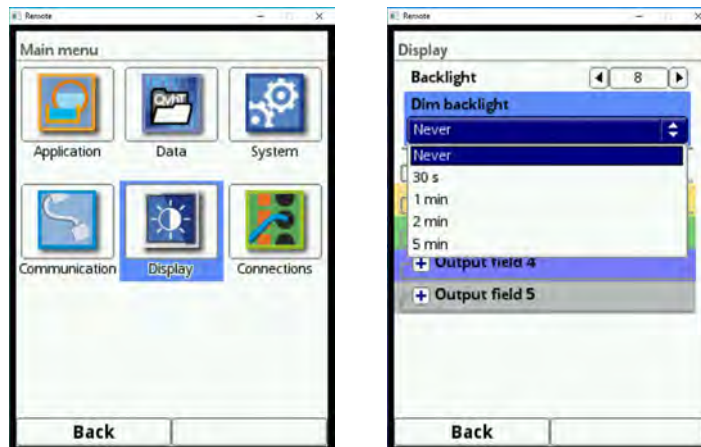

Fig. 27-1 Display/backlight/delay time

Backlight

The backlight can be adjusted in ten levels.

Adjust the backlight to the ambient conditions. Avoid setting the display too bright.

In order to extend the display life NIVUS recommend to enable the automatic display dimming option here (dim light). The display will dim automatically if it has not been used for a certain time. This period can be determined by using the delay time option.

As soon as settings are made on the transmitter (e. g. pressing a key) the display will go back to standard brightness.

Default setting: brightness level "8" and delay time "Never".

Output fields

The five main screen output fields (Flow, Level, Velocity, Temperature and Total) can be freely defined in terms of names and decimal places.



Note

The assignment of values to fields **CANNOT** be changed.

Example: the "Flow" field will **ALWAYS** issue the flow value even if it has been renamed to "Temperature".

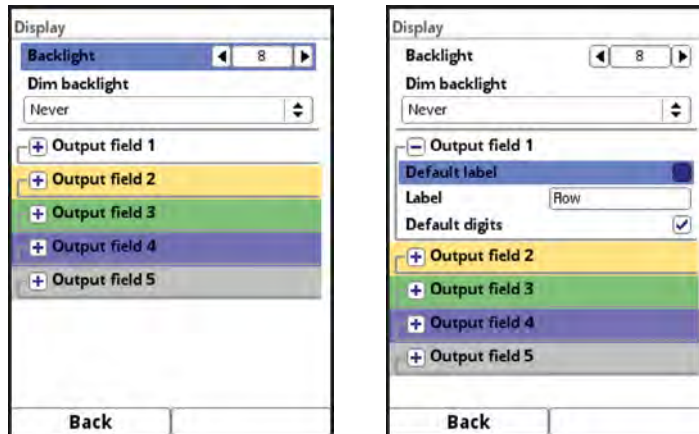

Fig. 27-2 Output fields and settings

➡ **Renaming procedure:**

1. Unfold the output field.
2. Untick >Standard Name<.
3. Enter a new name. This name can be chosen freely. The length of the name is limited to 16 characters.

The name entered **does not** change the values on the main screen.

The same procedure can be used to specify the desired **number of decimal digits**.

Here a maximum of five decimal digits is possible.



Note

During setting the decimal digits observe the measurement accuracies of the sensors and the measurement units set.

The temperature sensor e. g. has a maximum resolution of 0.1 K.

28 Connections

This submenu is required as soon as flow velocity sensors are not directly connected to the transmitter but by using the type iXT Ex Separator Module or Multiplexer MPX.

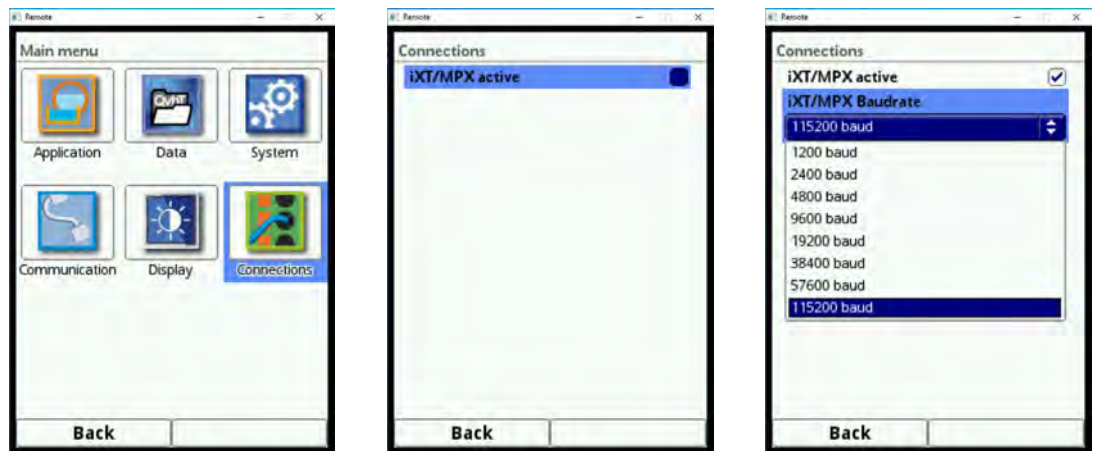

Fig. 28-1 Select connections/activation/baud rate

If an iXT/MPX is used tick this option in the selection field since otherwise sensor and module will not be recognised.

The **baud rate** can be adjusted here too.

Default setting: 115 200 baud.

Diagnosis

29 Basics of Diagnosis Menus

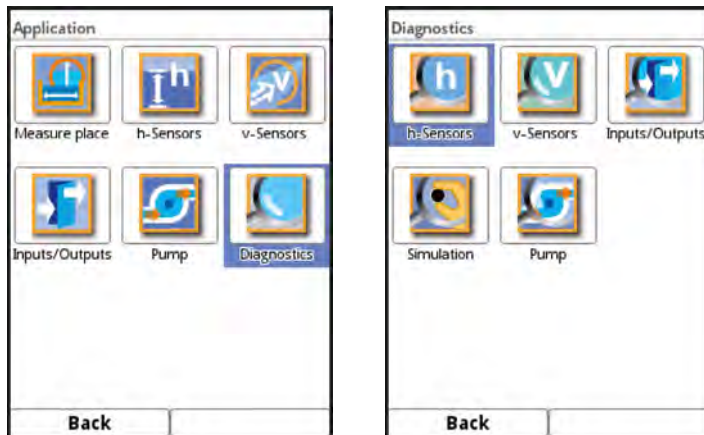

Fig. 29-1 Diagnosis menu

The >Diagnosis< menu can be found in menu >Application< and is divided into five submenus. The Diagnosis menu and all submenus are pure read-only and simulation menus.

In this section the following settings can be verified or simulated:

- h-Sensors (level and adjustment height)
- v-Sensors (article no., firmware version, serial no., velocity and scan status)
- Inputs and outputs (status and simulation)
- Simulation
- Pump



Important Note

Always follow the safety information on simulation on page 119.

30 Diagnosis h-Sensors

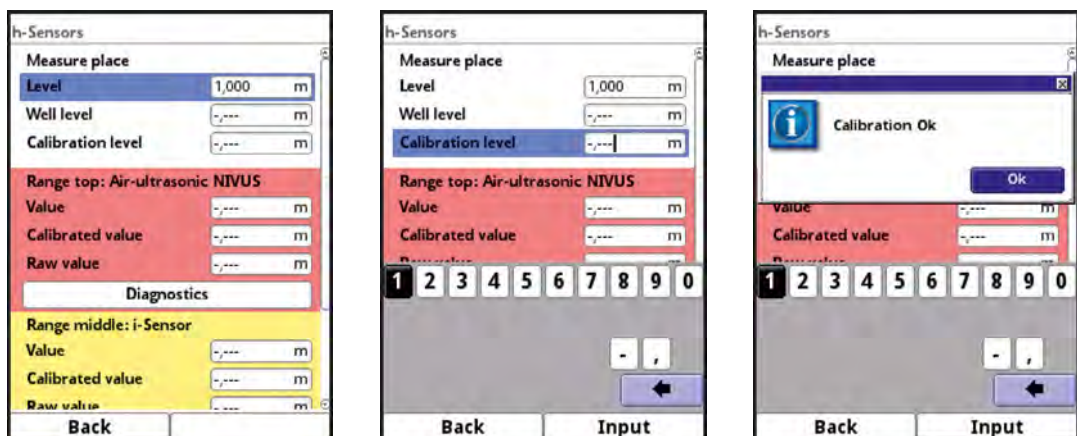

Fig. 30-1 Diagnosis menu h-Sensors

This menu has a relation to the menu >Applications</>h-Sensors<. Depending on the type and

number of sensors defined here the sections are indicated in the corresponding colours.

➡ See chapter „23.2 Setting Parameters in h-Sensors Menu (in pump shaft)“.

The Diagnosis screen shows the current level and the shaft level. The adjustment height can be set and must be confirmed with OK (Fig. 30-1). The adjustment height is equal to the offset and is normally specified when the h-sensor parameters are set.

Depending on which sensors are selected the value, the calibrated value or the raw value are indicated.

- **Value:** issued value
- **Calibrated value:** corrected used value
- **Raw value:** real measured value

Moreover it is possible to view (depending on the connected/selected sensor type) the ring-down behaviour if required by using the >Diagnosis< button.

31 Diagnosis v-Sensors

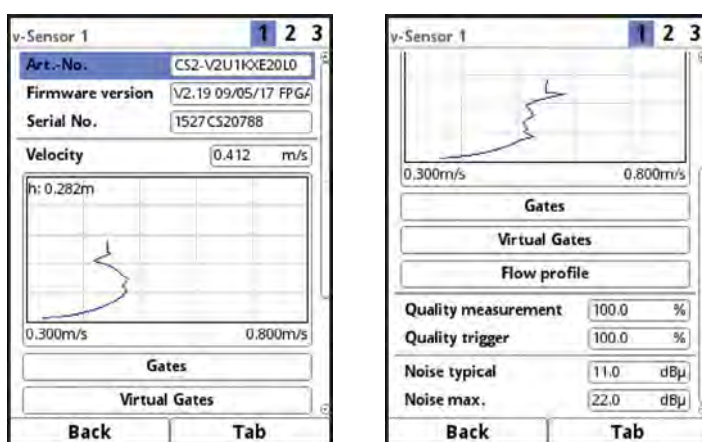

Fig. 31-1 Diagnosis menu v-Sensors

This menu is used to view information on hardware and current sensor data (see Fig. 31-1). Information details:

- Article no., firmware version and serial no. (important to customer service in case of requests)
- Velocity (numeric and as graph)
- Gates and virtual gates
- Flow profile
 - Perspective
 - Top
 - Front
 - Side
- Quality of measurement and trigger
- Noise typical and maximum

Use the right function key (Tab) to toggle between the individual sensors.

The individual measured velocities and the according levels can be indicated as table:

➡ Turn the rotary-pushbutton until the >Gates< field is highlighted blue.

↻ Pressing the rotary-pushbutton shows the current information as table.



Important Note

Information on the trigger and measurement quality as well as the signal cable noise is relevant to the NIVUS commissioning and service personnel.

The flow profile graph is calculated according to internal hydraulic methods.

The factors below are included with the flow profile calculation:

- Individual velocities
- Individual levels
- Channel profile
- Channel dimensions

The use of multiple flow sensors will improve the quality and properties of the represented graph. Even horizontal hydraulic interferences thus become visible.

32 Diagnosis Inputs and Outputs (analog und digital)



Fig. 32-1 Inputs/Outputs menu

⇒ See also chapter „23.4 Inputs and Outputs (analog and digital)“.

32.1 Analog Inputs

This menu is to indicate the voltage values and measurement values (assigned by using the measurement span) available on the analog inputs of the transmitter.

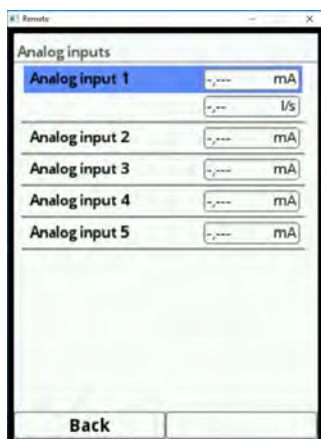

Fig. 32-2 Screen analog input values

32.2 Analog Outputs

This menu is to indicate the calculated voltage values and measurement values (assigned by using the measurement span) to be issued at the analog converter. Moreover it is possible to simulate the analog values.



Fig. 32-3 Screen analog output values



Note

This screen shows only the signals received by the analog converter to be issued. The real flowing currents are not issued.

External faulty wiring cannot be indicated in this menu.

This menu provides a simulation of the individual analog outputs.



Fig. 32-4 Password-protected simulation

DANGER



Personal injury or property damage

The simulation of analog outputs shall be executed by trained electricians only. The responsible expert personnel must have sound knowledge in the entire control procedures of the according facility.

Prepare the simulation process carefully:

- *Switch the following systems to manual operation.*
- *Disable actuating drives and similar or limit the according function.*

It is absolutely necessary to have a safety person available!

Disregarding may lead to personal injury or damage your facility.

NIVUS herewith in advance refuse any responsibility for any possible damage to persons or objects at any extent due to the extremely high risk of danger and unforeseeable consequences in the event of incorrect or faulty simulation!

DANGER



Effects on plant sections

The simulation of NivuFlow outputs will directly affect any following plant sections without any safety locking measures!

Simulations are allowed to be executed exclusively by qualified expert personnel.

Observe the hints contained within the earlier warning!



Note

Due to the reasons of safety mentioned before the simulation mode access is password-protected.

Due to reasons of personal safety share your password only with authorised and trained expert personnel!

➡ To simulate an analog output proceed as follows:

1. Enter your password.
2. Turn the rotary-pushbutton until the desired analog output is highlighted blue.
3. Press the rotary-pushbutton to activate (tick) the analog output.

4. Then specify the desired output current as numeric value. Observe that the analog output(s) will provide the specified voltages until the simulation is stopped.
5. Press the left function key to exit the simulation menu.

32.3 Digital Inputs

This menu shows the signals oncoming on the digital inputs. The information given in brackets shows the previously chosen function of the according digital input.

Active digital inputs are ticked.



Fig. 32-5 Screen digital inputs

32.4 Digital Outputs

The adjusted digital output values are indicated here. The information given in brackets shows the previously chosen function of the according digital output.

Active digital outputs are ticked.



Fig. 32-6 Screen digital outputs

A simulation of digital outputs is available in this menu too.



Fig. 32-7 Password-protected simulation

DANGER



Personal injury or property damage

The simulation of analog outputs shall be executed by trained electricians only. The responsible expert personnel must have sound knowledge on the entire control procedures of the according facility.

Prepare the simulation process carefully:

- Switch the following systems to manual operation.
- Disable the actuation drives and similar or limit the according function.

It is absolutely necessary to have a safety person available!

Disregarding may lead to personal injury or damage your facility.

NIVUS herewith in advance refuse any responsibility for any possible damage to persons or objects at any extent due to the extremely high risk of danger and unforeseeable consequences in the event of incorrect or faulty simulation!

DANGER



Effects on plant sections

The simulation of NivuFlow outputs will directly affect any following plant sections without any safety locking measures!

Simulations are allowed to be executed exclusively by qualified expert personnel.

Observe the hints contained within the earlier warning!



Note

Due to the reasons of safety mentioned before the simulation mode access is password-protected.

Due to reasons of personnel safety share your password only with authorised and trained expert personnel!

➡ To simulate a digital output proceed as follows:

1. Enter your password.
2. Turn the rotary-pushbutton until the desired digital output is highlighted blue.
3. Press the rotary-pushbutton to activate (tick) the digital output.
4. Then specify the desired output current as numeric value. Observe that the digital

output(s) will provide the specified voltages until the simulation is stopped.

5. Press the left function key to exit the simulation menu.

The simulation of each output can be activated in the same manner.

33 Diagnosis Simulation

This menu can be used to simulate theoretical flow. Simulation is executed by specifying assumed values for levels and velocities. These values are **not** real, will be erased on menu exit and the simulation mode will be finished. This menu is exclusively for verification of outputs and data communication.

Using the simulated values the transmitter calculates the prevailing flow rate based on the dimensions of the programmed channel.

This value is issued on the analog or digital outputs determined before.



Fig. 33-1 Enter password

DANGER



Personal injury or property damage

The simulation of analog outputs shall be executed by trained electricians only. The responsible expert personnel must have sound knowledge on the entire control procedures of the according facility.

Prepare the simulation process carefully.

- *Switch the following systems to manual operation.*
- *Disable actuating drives and similar or limit the according function.*

It is absolutely necessary to have a safety person available!

Disregarding may lead to personal injury or damage your facility.

NIVUS herewith in advance refuse any responsibility for any possible damage to persons or objects at any extent due to the extremely high risk of danger and unforeseeable consequences in the event of incorrect or faulty simulation.

DANGER



Effects on plant sections

The simulation of NivuFlow outputs will directly affect any following plant sections without any safety locking measures!

Simulations are allowed to be executed exclusively by qualified expert personnel.

Observe the hints contained within the earlier warning!



Note

Due to the reasons of safety mentioned before the simulation mode access is password-protected.

Due to reasons of personal safety share your password only with authorised and trained expert personnel!

➡ To start the simulation proceed as follows:

1. Enter your password.
2. Turn the rotary-pushbutton until the desired value to simulate (level or velocity) is highlighted blue.
3. Select the desired measurement value.
4. Confirm your selection with the right function key.
5. Press the left function key to exit the simulation menu.

The output box (see Fig. 33-2 no. 3) automatically shows the flow rate computed by considering both simulated values.

Digital and analog outputs possibly set behave as if they were actually programmed and will output these values effectively.

Issued signals and values are indicated on the display (see Fig. 33-2 no. 4 and 5).

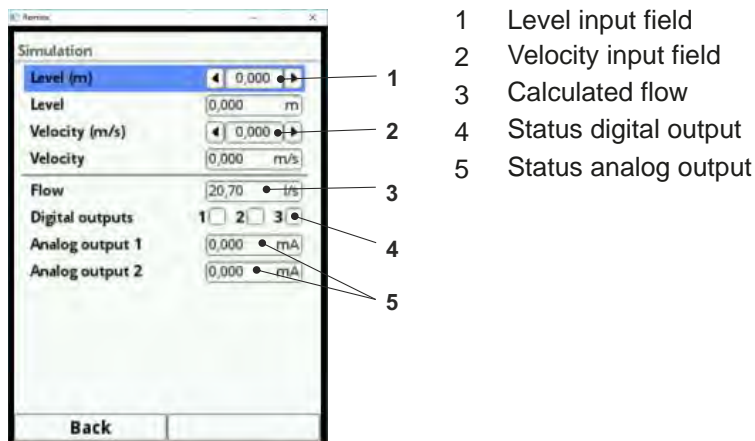

Fig. 33-2 Screen calculated values and issued states

34 Diagnosis Pump

This menu can be used to view information on the pumps and their current status. It is not possible to enter values here.

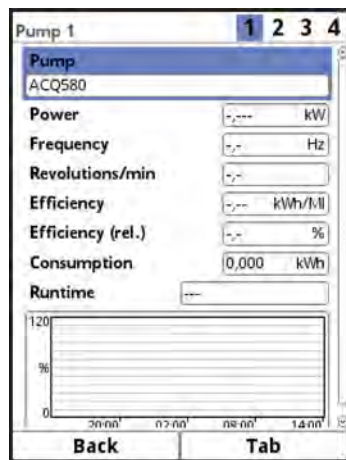

Fig. 34-1 Diagnosis Pump Menu

The screen provides information on:

- Power, Frequency, Revolutions, Efficiency, Efficiency (rel.), Consumption and Runtime
- The graphic representation corresponds to the main screen and covers the previous 24 hours.

Use Tab to browse through the pumps.

Maintenance and Cleaning

WARNING***Disconnect instrument from mains***

Disconnect the instrument from mains power and safeguard the higher system against restart before you begin maintenance works.

Disregarding may lead to electric shocks.

WARNING***Contamination by hazardous germs***

Due to being frequently used in wastewater applications, some portions of the measurement system may be loaded with hazardous germs. This is why precautionary measures shall be taken while being in contact with the system, cables and sensors.

Wear protective clothing.

35 Maintenance

35.1 Maintenance interval

The Type NivuFlow transmitters are conceived to be virtually free of calibration, maintenance and wear (requirements of the Industrial Safety Regulations are unaffected).

NIVUS recommends to have the entire measurement system inspected by the NIVUS customer service once per year.

Depending on the area of use the maintenance intervals however may vary.

Extent and intervals of maintenance depend on the following conditions:

- Measurement principle for Level Sensors
- Material wear
- Fluid and channel hydraulics
- General regulations for the operators of the measurement facility
- Ambient conditions

NIVUS recommends to have the measurement system completely be inspected by the manufacturer **after latest ten years**.

Generally the verification of instruments and sensors is a basic measure in order to improve operational reliability and to increase the lifetime.

35.2 Customer Service Information

For the recommended annual inspection of the entire measurement system and/or the extensive inspection after latest ten years contact our customer service:

NIVUS GmbH - Customer Service

Phone +49 (0) 7262 9191 - 922

Kundencenter@nivus.com

36 Cleaning

36.1 Transmitter

WARNING



Disconnect instrument from mains

Disconnect the instrument from mains power before cleaning.

Disregarding may lead to electric shocks.



Important Note

- Do not remove the **blue plastic rails** to clean the enclosure.
- Do not use the damp cloth to wipe over the **terminal clamp blocks**.

Clean the transmitter enclosure if required using a dry, lint-free cloth.

For stubborn dirt the enclosure can be cleaned using a damp cloth. Do not use sharp cleansing agents or solvents. Light household cleaners or soapy water can be used.

36.2 Sensors

The hints on how to maintain and clean the sensors shall be necessarily observed. These hints can be found in the Technical Instruction and/or the Instructor Manual.

This (these) document(s) is (are) part of the standard sensor delivery.

37 Dismantling/Disposal

Improper disposal may be harmful to the environment.

- ➡ Always dispose equipment components and packaging materials according to applicable local regulations on environmental standards for electronic products:
1. Disconnect the unit from mains power.
 2. Use appropriate tools to remove the connected cables from the faceplate of the instrument.
 3. Remove the transmitter from the DIN rail.
 4. Remove the buffer battery and make sure that the buffer battery will be disposed of separately.



EC WEEE-Directive logo

This symbol indicates that the Directive 2012/19/EU on waste electrical and electronic equipment requirements shall be observed on the disposal of the equipment.

The unit contains a buffer battery (Lithium coin cell), which must be disposed separately.

38 Accessories

| | |
|-------------|---|
| iXT0-xxx | Intelligent Ex-Separator Module |
| ZUB0 USB 08 | USB stick 8 GB for readout of parameter settings and measurement values using the NivuFlow USB interface |
| SW0N SPRO | Evaluation software, NivuSoft Professional with matched functions: documentation of measurement sites, output as graphs and tables, creation of statistics/reports etc. |
| BSL0xx | Overvoltage protection for measurement transmitters and sensors |

You can find more accessories in the valid NIVUS price list.

Index

A

| | |
|-----------------------|-----|
| Abbreviations | 11 |
| Accessories | 124 |
| Accident level | 14 |
| Air temperature | 83 |
| Article number | 24 |

B

| | |
|---------------------|-----|
| Backlight..... | 109 |
| Basic menus..... | 52 |
| Baud rate..... | 111 |
| Block v-measurement | |
| Digital inputs..... | 85 |
| Buffer battery..... | 123 |

C

| | |
|------------------------|-------------|
| Calming section..... | 40 |
| CE label..... | 21 |
| Change password | 60 |
| Chemicals | 31 |
| Colour code..... | 11 |
| Communication | |
| HART..... | 108 |
| Modbus | 108 |
| TCP/IP..... | 107 |
| Webserver..... | 107 |
| Components | |
| colour code..... | 11 |
| Compress..... | 98 |
| Connections | 11, 17, 111 |
| Control elements | 12, 49 |
| Copyright..... | 3 |
| Customer Service..... | 122 |

D

| | |
|-----------------------------|----|
| Damage in transit..... | 24 |
| Data depth | |
| Expert..... | 97 |
| Extended..... | 97 |
| Standard..... | 97 |
| USB stick..... | 97 |
| Data format | |
| USB stick..... | 96 |
| Data memory..... | 23 |
| Date/Time Selection | 92 |
| Delivery | 24 |
| Device identification | 21 |

| | |
|--------------------|-----|
| Device setup | 19 |
| Device Types..... | 24 |
| Diagnosis | |
| Basics..... | 112 |
| h-Sensors..... | 112 |
| Inputs | 114 |
| Outputs..... | 114 |
| Pump..... | 121 |
| Simulation | 119 |
| v-Sensors..... | 113 |
| Display | |
| Overview | 49 |
| Disposal | 123 |
| of materials..... | 17 |
| of products | 17 |

E

| | |
|-------------------------------|-----|
| EC WEEE-Directive | 123 |
| Environmental standards | 123 |
| ESD | |
| Electrostatic discharge..... | 30 |
| Risks | 30 |

F

| | |
|--------------------------|----|
| File names..... | 98 |
| Flow distribution | |
| 3-dimensional..... | 28 |
| Flow profiles | |
| asymmetric..... | 29 |
| Flow velocity | |
| Analog output..... | 83 |
| Flush with the wall..... | 75 |
| Function >Browse< | 92 |

G

| | |
|-------------------------|----|
| Gases..... | 31 |
| Germ contamination..... | 15 |

H

| | |
|----------------------|--------|
| HART | |
| Communication | 108 |
| Hazardous germs..... | 122 |
| Heavy shocks..... | 25 |
| Hotline | 48 |
| Humidity | 23, 25 |

| | | | |
|---|--------|--------------------------------------|--------|
| I | | | |
| Improper Use | 16 | Power supply..... | 22 |
| Installation instructions..... | 30 | Precautions | 15 |
| Installation place | 30 | Product construction | 19 |
| Installation regulations | 34 | Product overview..... | 19 |
| Instruction manual..... | 24 | Property rights..... | 3 |
| Instructions | | Protection | 22 |
| Operation start-up | 48 | Protection class..... | 22 |
| | | Protective conductor | 15 |
| L | | Q | |
| Language | | Q suppressed | |
| Operation | 102 | Low-flow volumes..... | 67 |
| Letter block..... | 50 | Qualified personnel | 18, 48 |
| Liability disclaimer | 16 | R | |
| Load Parameters..... | 98 | Radioactive radiation..... | 31 |
| Low-voltage network | 38 | RCD | 34 |
| M | | Reboot..... | 106 |
| Measurement windows | 28 | Reception inspection..... | 24 |
| Measures to prevent accidental contacts.. | 39 | Reflect | 27 |
| Modbus | | Reflection pattern | 27 |
| Communication | 108 | Replacement part ordering..... | 21 |
| N | | Reset | |
| Nameplates | 22 | Parameter | 107 |
| Names | 3 | Residual-current-operated protective | |
| Negative offset value..... | 73 | device | 34 |
| Non-original accessories..... | 25 | Restart | |
| Non-original parts..... | 25 | Measurement | 107 |
| Numeric keypad | 51 | Return | 25 |
| O | | Revision of parameters | 52 |
| Operating conditions | 22 | S | |
| Operation language..... | 102 | Safety Instructions..... | 14 |
| Original instruction manual..... | 10 | Save Parameters | 98 |
| Output fields | 109 | Sensors | 23 |
| Overvoltage category | 22 | Signal words..... | 14 |
| P | | SNTP | |
| Parts subject to wear and tear | 25 | Time server | 104 |
| Period..... | 92, 93 | Spare parts..... | 25 |
| Period of transmission | | Specifications | 22 |
| USB stick..... | 96 | Storage cycle | 23, 99 |
| Pollution degree | 22 | Sum impulses | |
| Power consumption | | Digital outputs | 87 |
| max. | 22 | Sunlight | 31 |
| typ. | 22 | System time | 104 |

T

| | |
|------------------------|-----|
| TCP/IP | |
| Communication | 107 |
| Temperature | 25 |
| Ambient, max. | 23 |
| Operating | 23 |
| Storage..... | 23 |
| Theoretical flow | 119 |
| Time zone..... | 104 |
| Totalising | 95 |
| Translation..... | 3 |
| Transport | 25 |

U

| | |
|--|-----|
| Ultrasonic Cross Correlation | 27 |
| Ultrasound reflection principle | 27 |
| Units system..... | 102 |
| Used symbols..... | 14 |
| Use in accordance with the requirements | 16 |
| User elements | 11 |
| User's Responsibilities | 17 |

V

| | |
|-----------------------|----|
| Vibrations | 25 |
| v suppressed | |
| Low-flow volumes..... | 67 |

W

| | |
|-------------------------|-----|
| Warning notices | |
| on the product | 15 |
| Water temperature | |
| Analog outputs | 83 |
| Webserver | |
| Communication | 107 |
| Wire | |
| colour code..... | 11 |
| Wire cross section..... | 35 |

Credits and Licenses

39 List of references of the licenses and codes used

The transmitter type NivuFlow uses code of the following Open Source Projects:

- Freetype (<http://www.freetype.org>)
- Libharu (<http://libharu.org>)
- Libjpeg (<http://www.ijg.org>)
- Libpng (<http://www.libpng.org>)
- Zlib (<http://www.zlib.net>)
- Mini-XML (<http://www.msweet.org>)
- Nano-X/nxlib (<http://www.microwindows.org>)
- FLTK (<http://www.fltk.org>)
- Appendix1: LGPL
- Appendix2: MPL



Note

If you have any questions concerning licenses refer to opensource@nivus.com

EU Konformitätserklärung

EU Declaration of Conformity

Déclaration de conformité UE

NIVUS GmbH
Im Täle 2
75031 Eppingen

Telefon: +49 07262 9191-0
Telefax: +49 07262 9191-999
E-Mail: info@nivus.com
Internet: www.nivus.de

Für das folgend bezeichnete Erzeugnis:

For the following product:

Le produit désigné ci-dessous:

| | |
|---------------------|--|
| Bezeichnung: | Durchflussmessumformer stationär mit internem 2G/3G/4G Modem zur Datenfernübertragung NivuFlow 7xx/Energy Saver |
| <i>Description:</i> | <i>Permanent flow measurement transmitter with internal modem for remote data transmission</i> |
| <i>Désignation:</i> | <i>Transmetteur de débit stationnaire avec modem intégré pour transmission de données</i> |
| Typ / Type: | NF7-... / NR7-... |

erklären wir in alleiniger Verantwortung, dass die auf dem Unionsmarkt ab dem Zeitpunkt der Unterzeichnung bereitgestellten Geräte die folgenden einschlägigen Harmonisierungsvorschriften der Union erfüllen:

we declare under our sole responsibility that the equipment made available on the Union market as of the date of signature of this document meets the standards of the following applicable Union harmonisation legislation:

nous déclarons, sous notre seule responsabilité, à la date de la présente signature, la conformité du produit pour le marché de l'Union, aux directives d'harmonisation de la législation au sein de l'Union:

- 2014/53/EU
- 2011/65/EU

Bei der Bewertung wurden folgende einschlägige harmonisierte Normen zugrunde gelegt bzw. wird die Konformität erklärt in Bezug auf die nachfolgend genannten anderen technischen Spezifikationen:

The evaluation assessed the following applicable harmonised standards or the conformity is declared in relation to other technical specifications listed below:

L'évaluation est effectuée à partir des normes harmonisées applicable ou la conformité est déclarée en relation aux autres spécifications techniques désignées ci-dessous:

- EN 61010-1:2010 + A1:2019 + A1:2019/AC:2019
- EN 61326-1:2013
- Draft ETSI EN 301 489-52 V1.2.1
- EN 301 908-1 V15.2.0 (UMTS/3G, LTE/4G)
- EN 301 908-13 V13.2.1 (LTE/4G)
- EN 62311:2008
- EN 301 489-1 V2.2.3
- EN 301 511 V12.5.1 (GSM/2G)
- EN 301 908-2 V13.1.1 (UMTS/3G)

Diese Erklärung wird verantwortlich für den Hersteller:

This declaration is submitted on behalf of the manufacturer:

Le fabricant assume la responsabilité de cette déclaration:

NIVUS GmbH
Im Täle 2
75031 Eppingen
Germany

abgegeben durch / represented by / faite par:

Ingrid Steppe (Geschäftsführerin / *Managing Director* / *Directeur général*)

Eppingen, den 21.10.2022

Gez. *Ingrid Steppe*

UK Declaration of Conformity

NIVUS GmbH
Im Tale 2
75031 Eppingen

Telefon: +49 07262 9191-0
Telefax: +49 07262 9191-999
E-Mail: info@nivas.com
Internet: www.nivas.de

For the following product:

| | |
|---------------------|---|
| Description: | Permanent flow measurement transmitter with internal modem 2G/3G/4G for remote data transmission NivuFlow 7xx / Energy Saver |
| Type: | NF7-... / NR7-... |

we declare under our sole responsibility that the equipment made available on the UK market as of the date of signature of this document meets the standards of the following applicable UK harmonisation legislation:

- SI 2017 / 1206 The Radio Equipment Regulations 2017
- SI 2012 / 3032 The Restriction of the Use of Certain Hazardous Substances in Electrical and Electronic Equipment Regulations 2012

The evaluation assessed the following applicable harmonised standards or the conformity is declared in relation to other technical specifications listed below:

- BS EN 61010-1:2010 + A1:2019 + A1:2019/AC:2019
- BS EN 61326-1:2013
- Draft ETSI EN 301 489-52 V1.2.1
- BS EN 301 908-1 V15.2.0 (UMTS/3G, LTE/4G)
- BS EN 301 908-13 V13.2.1 (LTE/4G)
- BS EN 62311:2008
- BS EN 301 489-1 V2.2.3
- BS EN 301 511 V12.5.1 (GSM/2G)
- BS EN 301 908-2 V13.1.1 (UMTS/3G)

This declaration is submitted on behalf of the manufacturer:

NIVUS GmbH
Im Tale 2
75031 Eppingen
Germany

represented by:

Ingrid Steppe (Managing Director)

Eppingen, 21/10/2022

Signed by *Ingrid Steppe*

EU Konformitätserklärung

EU Declaration of Conformity

Déclaration de conformité UE

NIVUS GmbH
Im Täle 2
75031 Eppingen

Telefon: +49 07262 9191-0
Telefax: +49 07262 9191-999
E-Mail: info@nivus.com
Internet: www.nivus.de

Für das folgend bezeichnete Erzeugnis:

For the following product:

Le produit désigné ci-dessous:

| | |
|---------------------|---|
| Bezeichnung: | Durchflussmessumformer stationär NivuFlow 7xx / Energy Saver |
| <i>Description:</i> | <i>permanent flow measurement transmitter</i> |
| <i>Désignation:</i> | <i>convertisseur de mesure de débit fixe</i> |
| Typ / Type: | NF7-... / NR7-... |

erklären wir in alleiniger Verantwortung, dass die auf dem Unionsmarkt ab dem Zeitpunkt der Unterzeichnung bereitgestellten Geräte die folgenden einschlägigen Harmonisierungsvorschriften der Union erfüllen:

we declare under our sole responsibility that the equipment made available on the Union market as of the date of signature of this document meets the standards of the following applicable Union harmonisation legislation:

nous déclarons, sous notre seule responsabilité, à la date de la présente signature, la conformité du produit pour le marché de l'Union, aux directives d'harmonisation de la législation au sein de l'Union:

- 2014/30/EU
- 2014/35/EU
- 2011/65/EU

Bei der Bewertung wurden folgende einschlägige harmonisierte Normen zugrunde gelegt bzw. wird die Konformität erklärt in Bezug die nachfolgend genannten anderen technischen Spezifikationen:

The evaluation assessed the following applicable harmonised standards or the conformity is declared in relation to other technical specifications listed below:

L'évaluation est effectuée à partir des normes harmonisées applicable ou la conformité est déclarée en relation aux autres spécifications techniques désignées ci-dessous:

- EN 61326-1:2013
- EN 61010-1:2010 + A1:2019 + A1:2019/AC:2019

Diese Erklärung wird verantwortlich für den Hersteller:

This declaration is submitted on behalf of the manufacturer:

Le fabricant assume la responsabilité de cette déclaration:

NIVUS GmbH
Im Täle 2
75031 Eppingen
Allemagne

abgegeben durch / *represented by / faite par:*

Ingrid Steppe (Geschäftsführerin / *Managing Director / Directeur général*)

Eppingen, den 21.10.2022

Gez. *Ingrid Steppe*

UK Declaration of Conformity

NIVUS GmbH
Im Tale 2
75031 Eppingen

Telefon: +49 07262 9191-0
Telefax: +49 07262 9191-999
E-Mail: info@nivus.com
Internet: www.nivus.de

For the following product:

| | |
|---------------------|---|
| Description: | Permanent flow measurement transmitter NivuFlow 7xx / Energy Saver |
| Type: | NF7-... / NR7-... |

we declare under our sole responsibility that the equipment made available on the UK market as of the date of signature of this document meets the standards of the following applicable UK harmonisation legislation:

- SI 2016 / 1091 The Electromagnetic Compatibility Regulations 2016
- SI 2016 / 1101 The Electrical Equipment (Safety) Regulations 2016
- SI 2012 / 3032 The Restriction of the Use of Certain Hazardous Substances in Electrical and Electronic Equipment Regulations 2012

The evaluation assessed the following applicable harmonised standards or the conformity is declared in relation to other technical specifications listed below:

- BS EN 61326-1:2013
- BS EN 61010-1:2010 + A1:2019 + A1:2019/AC:2019

This declaration is submitted on behalf of the manufacturer:

NIVUS GmbH
Im Tale 2
75031 Eppingen
Germany

represented by:

Ingrid Steppe (Managing Director)

Eppingen, 21/10/2022

Signed by *Ingrid Steppe*